

User Guide

NTC-140W Series – 4G WiFi M2M Router



Important Notice

This device, like any wireless device, operates using radio signals which cannot guarantee the transmission and reception of data in all conditions. While the delay or loss of signal is rare, you should not rely solely on any wireless device for emergency communications or otherwise use the device in situations where the interruption of data connectivity could lead to death, personal injury, property damage, data loss, or other loss. NetComm Wireless accepts no responsibility for any loss or damage resulting from errors or delays in transmission or reception, or the failure of the NetComm Wireless NTC-140W to transmit or receive such data.

Safety and Hazards



Do not connect or disconnect cables or devices to or from the USB port, SIM card tray, Ethernet port or the terminals of the Molex power connector in hazardous locations such as those in which flammable gases or vapors may be present, but normally are confined within closed systems; are prevented from accumulating by adequate ventilation; or the location is adjacent to a location from which ignitable concentrations might occasionally be communicated.

Copyright

Copyright© 2015 NetComm Wireless Limited. All rights reserved.

The information contained herein is proprietary to NetComm Wireless. No part of this document may be translated, transcribed, reproduced, in any form, or by any means without prior written consent of NetComm Wireless.



Note: This document is subject to change without notice.

Save our environment

When this equipment has reached the end of its useful life, it must be taken to a recycling centre and processed separately from domestic waste.

The cardboard box, the plastic contained in the packaging, and the parts that make up this device can be recycled in accordance with regionally established regulations. Never dispose of this electronic equipment along with domestic waste. You may be subject to penalties or sanctions under the law. Instead, ask for disposal instructions from your municipal government.

Please be responsible and protect our environment.

This manual covers the following products:

NetComm Wireless NTC-140W-01

NetComm Wireless NTC-140W-02

DOCUMENT VERSION	DATE
1.0 - Initial document release	30 July 2014
1.1 - Added maximum antenna gain value to Safety and product care section, updated TR-069 configuration description.	13 August 2014
1.2 – Updated for new PPPoE functionality.	12 November 2014
1.3 – Added description of User defined executable endpoint.	4 December 2014
1.4 – Added carrier activation / de-activation details.	12 December 2014
1.5 – Added note about WiFi LED status when both WiFi AP and Client mode are enabled simultaneously.	19 January 2015
1.6 – Added WiFi channel bandwidth selection, Email settings fields, Added new Event notification event types, other minor updates.	20 February 2015
1.7 – Updated some screenshots pertaining to activation on the NTC-140W-01 model, WAN failover and IO configuration. Added OpenVPN SSL/TLS handshake details, HTTPS key management section updated and renamed to Server certificate.	7 May 2015.

Table 1 - Document Revision History

Table of contents

Overview	6
Introduction	6
Target audience.....	6
Prerequisites	6
Notation	6
Product introduction	7
Product overview	7
Product features.....	7
Package contents.....	7
Physical dimensions and indicators	8
Physical dimensions	8
LED indicators	9
Ethernet port LED indicators	11
Interfaces	12
Placement of the router	13
Mounting options.....	13
DIN rail mounting bracket.....	13
Wall mounted via DIN rail bracket	14
DIN rail mount	14
Pole mount using DIN rail bracket	15
Desk mount.....	15
Installation and configuration of the NTC-140W Series router	16
Powering the router	16
Installing the router	16
Advanced configuration	17
Status	17
Networking	22
Wireless WAN.....	22
LAN	35
Wireless settings.....	39
Ethernet LAN/WAN.....	47
PPPoE	49
WAN failover.....	50
Routing	52
VPN	61
Services	74
Dynamic DNS.....	74
Network time (NTP).....	75
Data stream manager	76
PADD.....	81
SNMP	82
TR-069.....	84
GPS	86
IO configuration	88
Event notification	90
Email settings	93
SMS messaging	94
System	110
Log	110
System configuration	115
Administration	119
Watchdogs.....	127
Power management	130
USB-OTG.....	133
Storage.....	134
Reboot.....	135
Appendix A: Tables	136
Appendix B: Default Settings	137
Restoring factory default settings	138
Appendix C: Recovery mode	139
Accessing recovery mode	139
Status	140
Log	140
Application Installer	141
Settings.....	141
Reboot.....	141
Appendix D: HTTPS - Uploading a self-signed certificate	142
Appendix E: RJ-45 connectors	144

Appendix G: Input/Output	145
Overview	145
Appendix H: Obtaining a list of RDB variables	150
Appendix I: Using USB devices and MicroSD™ cards	151
Accessing USB/SD card storage devices	151
Host and Device mode	151
Technical Data	152
Safety and product care	154
Product Warranty	159

Overview

Introduction

This document provides you all the information you need to set up, configure and use the NetComm Wireless NTC-140W Series router.

Target audience

This document is intended for system integrators or experienced hardware installers who understand telecommunications terminology and concepts.

Prerequisites

Before continuing with the installation of your NTC-140W Series router, please confirm that you have the following:

-  An electronic computing device with a working Ethernet network adapter and a web browser such as Internet Explorer, Mozilla Firefox or Google Chrome.

Notation

The following symbols are used in this user guide:



The following note requires attention.



The following note provides a warning.



The following note provides useful information.

Product introduction

Product overview

- ⚡ Powerful and flexible industrial cellular router platform supporting LTE with fallback to 3G/UMTS and GSM/GPRS/EDGE (Fallback only applies to certain models)
- ⚡ Ideal for providing primary and backup wireless connectivity over LTE networks
- ⚡ Industrial Features – rugged enclosure, wide operating temperature range, wall mount option and a flexible range of power options
- ⚡ Embedded Linux operating system allowing for the installation of custom applications. Software Development Kit (SDK) is available
- ⚡ Web interface for easy centralized configuration and management from any PC
- ⚡ Two 10/100/1000 Base T ports for Ethernet connection
- ⚡ VPN support for establishing a secure connection over public cellular network using OpenVPN
- ⚡ Supports SNMP with cellular specific MIB, PPPoE, RIP, VRRP. DDNS, MAC /NET address filtering, Open VPN, DHCP/DHCP relay
- ⚡ System monitoring, remote diagnostics and configuration over the air, diagnostic log viewer via browser
- ⚡ 802.11n WiFi access point or client with 2x2 MIMO antenna technology
- ⚡ Integrated GPS support
- ⚡ TR-069 device management (optional)
- ⚡ Ignition Sense capability for graceful shutdown and startup in vehicle applications
- ⚡ Configurable power save mode with minimum current draw when not operational
- ⚡ Tested for vehicular applications IEC Class 5M2 and MIL-STD-810F Method 516.5.

Product features

The robust and intelligent NetComm 4G WiFi M2M Router is designed to provide real-time M2M data connectivity even in harsh environments. The NTC-140W creates reliable point-to-point or point-to-multi-point wide area network (WAN) connections for a variety of mission critical applications such as primary broadband, video surveillance, retail, payments, in-vehicle wireless hotspot and business continuity.

Package contents

The NetComm Wireless NTC-140W Series router package consists of:

- ⚡ 1 x NetComm Wireless NTC-140W Series router
- ⚡ 2 x Cellular antennas
- ⚡ 2 x WiFi antennas
- ⚡ 1 x 1.5m Black Ethernet cable
- ⚡ 1 x DIN rail mounting bracket
- ⚡ 1 x Quick start guide
- ⚡ 1 x Power supply cable (2 metres) with fitted Molex connector
- ⚡ 1 x WiFi security card

If any of these items are missing or damaged, please contact NetComm Wireless Support immediately. The NetComm Wireless Support website can be found at: <http://support.netcommwireless.com>.

Physical dimensions and indicators

Physical dimensions

Below is a list of the physical dimensions of the NTC-140W Series router.



Figure 1 – NTC-140W Series router Dimensions

NTC-140W SERIES ROUTER (WITHOUT EXTERNAL ANTENNAS ATTACHED)	
Length	143 mm
Depth	107 mm
Height	34 mm
Weight	~235g

Table 2 - Device Dimensions

LED indicators

The NTC-140W Series router uses 8 LEDs to display the current system and connection status.

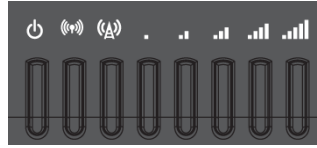

Figure 2 - NTC-140W Series router LED Indicators



























LED ICON	NAME	COLOUR	STATE	DESCRIPTION
	Power		Off	Power off
			Double flash	Powering up
			On	Power on
			On	Power on in recovery mode
			Slow flashing	Hardware error, such as SIM not inserted
	WiFi ¹		Off	Radio Off
			On	WiFi Access Point is enabled
			Blinking	Traffic via WiFi
			On	Client mode is enabled, WiFi Access Point is disabled
			Blinking	Traffic via WiFi in client mode
	Network		Off	Radio Off
			On	Connected via WWAN
			Blinking ²	Traffic via WWAN
			Slow flashing	Connecting PDP
			On	Registered network
			Slow flashing	Registering network
			Slow flashing	SIM PIN locked
			Fast flashing	SIM PUK locked
			On	Can't connect
	Signal strength		On	LTE signal
			On	WCDMA signal
			On	GSM signal

Table 3 - LED Indicators

¹ When both the WiFi Access Point and WiFi client mode are enabled simultaneously, the WiFi LED displays as green. In this situation, you are not able to see the status of the WiFi client mode through observation of the LED.

² The term “blinking” means that the LED may pulse, with the intervals that the LED is on and off not being equal. The term “flashing” means that the LED turns on and off at equal intervals.

Signal strength LEDs

The following tables list the signal strength range corresponding with the number of lit signal strength LEDs.

LTE signal mapping (Green)

NUMBER OF LIT LEDs	SIGNAL STRENGTH
All LEDs unlit	≤ -120 dBm
1	-115 dBm to -119dBm
2	-105 dBm to -114 dBm
3	-100 dBm to -104 dBm
4	-90 dBm to -99 dBm
5	> -90 dBm

WCDMA signal mapping (Amber)

NUMBER OF LIT LEDs	SIGNAL STRENGTH
All LEDs unlit	< -109 dBm
1	-109 dBm to -102dBm
2	-101 dBm to -92 dBm
3	-91 dBm to -86 dBm
4	-85 dBm to -78 dBm
5	≥ -77 dBm

Table 4 - Signal strength LED descriptions

GSM signal mapping (Red)

NUMBER OF LIT LEDs	SIGNAL STRENGTH
All LEDs unlit	≤ -109 dBm
1	-102 dBm to -108dBm
2	-93 dBm to -101 dBm
3	-87 dBm to -92 dBm
4	-86 dBm to -78 dBm
5	> -78 dBm

LED update interval

The signal strength LEDs update within a few seconds with a rolling average signal strength reading. When selecting a location for the router or connected or positioning an external antenna, please allow up to 20 seconds for the signal strength LEDs to update before repositioning.

Ethernet port LED indicators

Each of the Ethernet ports of the NTC-140W Series router have two LED indicators on them.

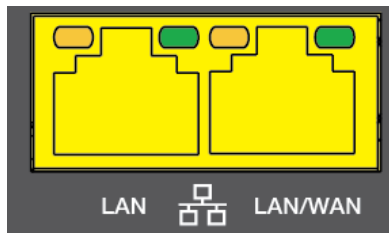

Figure 3 - Ethernet port LED indicators

The table below describes the statuses of each light and their meanings.

LED	STATUS	DESCRIPTION
Green	On	There is a valid network link.
	Blinking	There is activity on the network link.
	Off	No valid network link detected.
Amber	On	The Ethernet port is operating at a speed of 1000Mbps.
	Off	The Ethernet port is operating at a speed of 10/100Mbps or no Ethernet cable is connected.

Table 5 - Ethernet port LED indicators description



Do not connect or disconnect cables or devices to or from the Ethernet ports in hazardous locations such as those in which flammable gases or vapors may be present, but normally are confined within closed systems; are prevented from accumulating by adequate ventilation; or the location is adjacent to a location from which ignitable concentrations might occasionally be communicated.

Interfaces

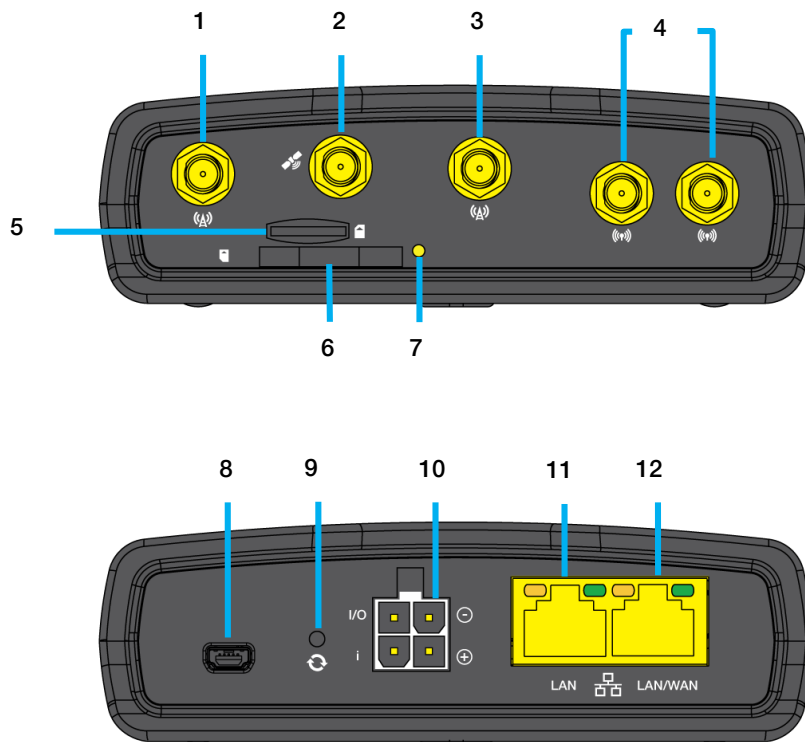

Figure 4 - Interfaces

NO.	ITEM	DESCRIPTION
1	Cellular Main antenna connector	SMA connector for main cellular antenna.
2	GPS antenna connector	SMA connector for GPS antenna (not included in package).
3	Cellular AUX antenna connector	SMA connector for auxiliary cellular antenna.
4	WiFi antenna connectors	Reverse polarity SMA connectors for WiFi antennas.
5	microSD™ card slot	Insert a microSD™ card here to provide additional storage (Optional).
6	SIM card slot	Insert SIM card here.
7	SIM tray eject button	Press to eject the SIM tray
8	Micro USB 2.0 OTG port	Provides connectivity for optional external storage or a USB Ethernet dongle. Supplies up to 0.5A to connected device.
9	Reset button	<p>Press and hold for less than 5 seconds to reboot to normal mode. The LEDs are green and extinguish in sequence to indicate that the router will reboot normally if the button is released during this period.</p> <p>Press and hold for 5 to 15 seconds to reboot to recovery mode. The LEDs are amber and extinguish in sequence to indicate that the router will reboot to recovery mode if the button is released during this period.</p> <p>Press and hold for 15 to 20 seconds to reset the router to factory default settings. The LEDs are red and extinguish in sequence to indicate that the router will reset to factory default settings if the button is released during this period.</p>
10	Molex Mini-Fit™ Jr. 2 x 2 receptacle	<p>Connect the provided power supply here. The Molex receptacle provides:</p> <ul style="list-style-type: none"> • Ground (-) • Power (+) • I/O terminal • (i) ignition input detection terminal.
11	LAN port	LAN port for wired Ethernet clients.
12	LAN/WAN port	LAN or WAN port for wired Ethernet clients or to bridge another network connection.

Table 6 – Interfaces

Placement of the router

The four external high-performance antennas supplied with the router are designed to provide optimum signal strength in a wide range of environments. If you find the signal strength is weak, try adjusting the orientation of the antennas. If you are unable to get an acceptable signal, try moving the router to a different place or mounting it differently.



Note: When selecting a location for the router, allow at least 20 seconds for the signal strength LEDs to update before trying a different location.

Mounting options

The NTC-140W Series router can be quickly and easily mounted in a variety of locations.

Mounted flat against the wall

When mounted flat against the wall, the NTC-140W Series router has a slimline form factor. Use appropriately sized screws in the mounting holes provided on the base of the unit.

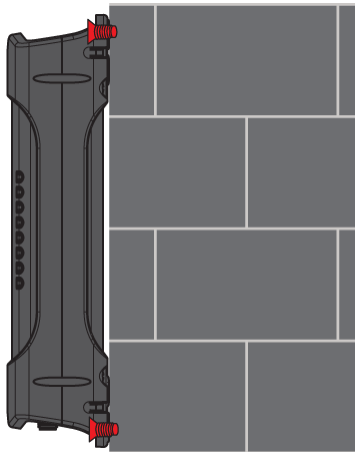

Figure 5 - Wall mount - Flat against the wall

DIN rail mounting bracket

V Bend allows you to snap the DIN bracket onto the middle of a DIN rail rather than sliding it onto the end.

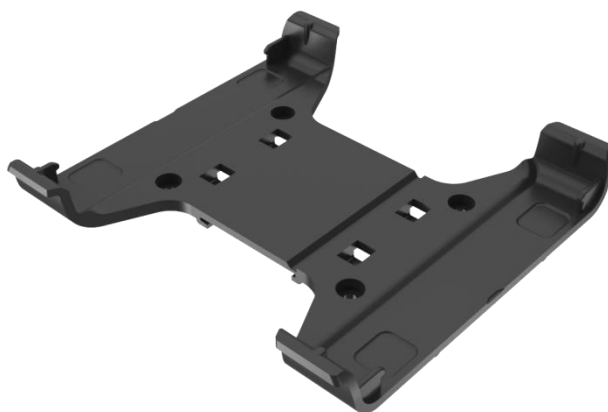

Figure 6 – DIN rail mounting bracket

Wall mounted via DIN rail bracket

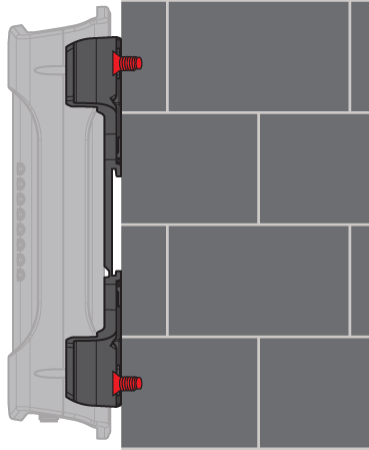

Figure 7 - Wall mounted via DIN rail bracket

DIN rail mount

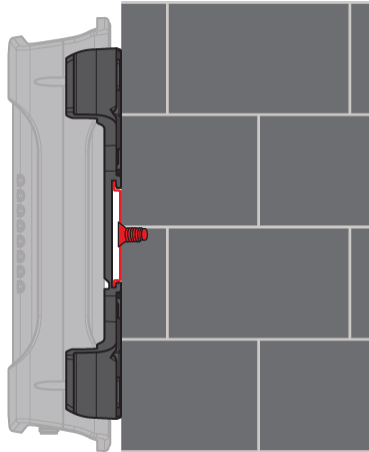

Figure 8 - DIN rail mount

Pole mount using DIN rail bracket

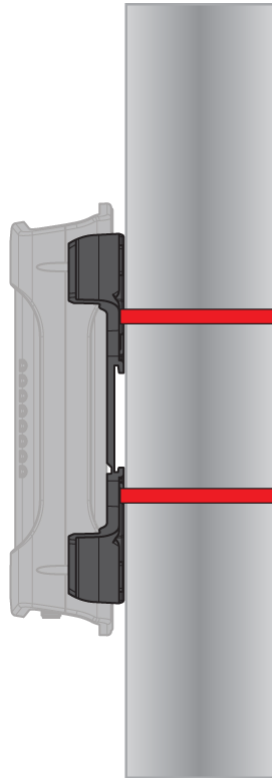

Figure 9 - Pole mount using DIN rail bracket

Desk mount

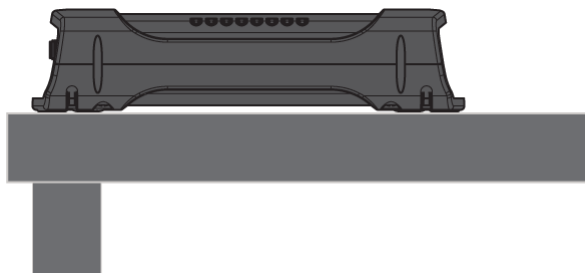

Figure 10 - Desk mount

Installation and configuration of the NTC-140W Series router

Powering the router

The NTC-140W Series router may be powered using the included power supply cable with 8-40V to the Molex connector. A suitable power supply (PSU-0039) is available as an accessory. The diagram below shows the layout of the pins on the Molex connector.

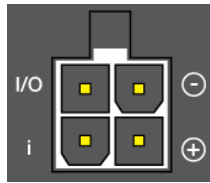

Figure 11 - Molex connector

TERMINAL	DESCRIPTION
-	Ground wire.
+	Positive wire for power.
i	Dedicated terminal for ignition detection.
I/O	Input/output detection.

Table 7 - Locking power block pin outs

Installing the router

Follow these steps to complete the installation process. For a more detailed description, please refer to the Quick Start Guide included in the package contents.

1. Using a paper clip, press the SIM Eject button to eject the SIM card tray. Place the SIM card in the tray and then insert the loaded tray into the SIM slot with the gold side facing up.
2. Attach the cellular and WiFi antennas to their respective connectors.
3. Connect equipment that requires network access to the LAN port of your router. This may be your computer for advanced configuration purposes, or your end equipment which requires data access via the NTC-140W Series router. You can connect one device directly, or several devices using a network switch.
4. Connect the power source to the router. Wait approximately 2 minutes for your NTC-140W Series router to start up. To check the status of your router, compare the LED indicators on the device with those listed in the [LED indicators](#) section of this guide.



Do not connect or disconnect cables or devices to or from the USB port, SIM card tray, Ethernet port or the terminals of the Molex power connector in hazardous locations such as those in which flammable gases or vapors may be present, but normally are confined within closed systems; are prevented from accumulating by adequate ventilation; or the location is adjacent to a location from which ignitable concentrations might occasionally be communicated.

Advanced configuration

The NTC-140W Series router comes with pre-configured settings that should suit most customers. For advanced configuration, log in to the web-based user interface of the router.

To log in to the web-based user interface:

1. Open a web browser (e.g. Internet Explorer, Firefox, Google Chrome), type <http://192.168.1.1> into the address bar and press **Enter**. The web-based user interface log in screen is displayed.

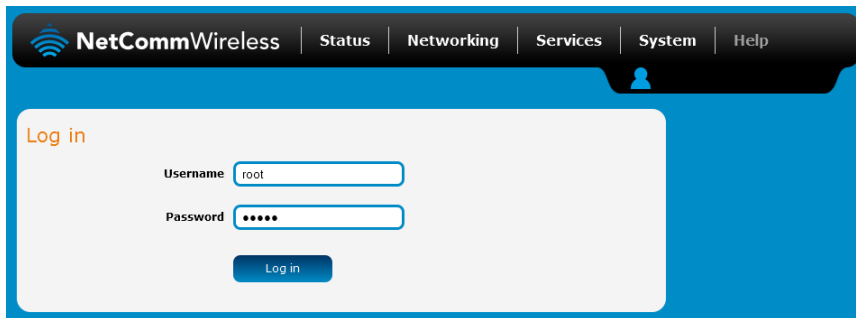

Figure 12 – Log in prompt for the web-based user interface

2. Enter the login username and password. If this is the first time you are logging in or you have not previously configured the password for the “root” or “admin” accounts, you can use one of the default account details to log in.

ROOT MANAGER ACCOUNT	
Username:	root
Password:	admin

Table 8 - Management account login details – Root manager

ADMIN MANAGER ACCOUNT	
Username:	admin
Password:	admin

Table 9 - Management account login details – Admin manager





Note:

- The admin manager account allows you to manage all settings of the router except functions such as firmware upgrade, device configuration backup and restore and reset to factory default settings, which are privileged only to the root manager account.
- For security reasons, we highly recommend that you change the passwords for the root and admin accounts upon initial installation. You can do so by navigating to the System and then Administration page.



The Status page is displayed when you have successfully logged in.

Status

The status page of the web interface provides system related information and is displayed when you log in to the NTC-140W Series router management console. The status page shows System information, LAN details, Cellular connection status, Packet data connection status, Wireless LAN status and Advanced status details. You can toggle the sections from view by clicking the  or  buttons to show or hide them. Extra status boxes will appear as additional software features are enabled (e.g. VPN connectivity).

 **NetCommWireless**

[Status](#) | [Networking](#) | [Services](#) | [System](#) | [Help](#)

 root 

^ System information

System up time  3 Days 14:12:36	Device version Hardware version 1.0 Serial number XXXXXXXXXXXXXX Firmware version V.X.X.XX	Cellular module Model MC7354 Module firmware 05.05.16.03 IMEI XXXXXXXXXXXXXX MEID XXXXXXXXXXXXXX
--	--	---

^ LAN

IP
192.168.1.2 / 255.255.255.0

MAC address
00:60:64:DE:EA:17

Ethernet port status #1
! Down

Ethernet port status #2
✔ Up / 1000 Mbps / FDX

^ Cellular connection status

SIM status SIM OK ✔ Signal strength (dBm) -78 dBm (Medium) 	Operator selection N/A Current operator N/A Roaming status Not roaming	Allowed bands All Bands Current band CDMA 800-MHz (BC 0) Coverage CDMA2000 1X
--	--	---

^ WWAN connection status

Profile name
Profile1 [Show data usage](#)

Status Connected	WWAN IP 10.232.40.251	APN Blank
Default profile Yes	DNS server 198.224.146.119 198.224.147.135	Connection uptime 14:25:11

^ WLAN AP status

#	Status	Network Name (SSID)	MAC address	Channel	Network authentication	Station info
1	Enabled	NetComm 6801	00:60:64:DE:EA:18	1	WPA2PSK	Station info

^ Advanced status

MDN XXXXXXXXXX SID / NID XX / XX DC input voltage 12.18V HSUPA category 6 HSDPA category 24 SIM ICCID XXXXXXXXXXXXXXXXXXXX	Power input mode DCJack Pn index 460 IMSI XXXXXXXXXXXXXX Channel number (UARFCN) 425 Module PRIID Revision 01.02 Module PRIID PRI part number 9902975	P-ESN XXXXXXXXXX, XXXXXXXX PRL Version 15358 PRI carrier XXX PRI config XXX_XXX_XXX_XXX MIP profile information Profile:0 Enabled NAI:XXXXXXXX@XXXXX.XXX Home Addr:0.0.0.0 Primary HA:255.255.255.255 Secondary HA:255.255.255.255 MN-AAA SPI:2 MN-HA SPI:300 Rev Tun:1 MN-AAA SS:Set MN-HA SS:Set Packet service status Attached
---	--	---

^ WAN

Priority
✔ 1. wwan.0 [Link]

^ External storage

No media found

^ USB-OTG

Current status
Device mode

^ SMS status

Received message count
1

^ Event notification

Event count
2

Figure 13 - NTC-140W-01 status page

NetComm Wireless 4G WiFi M2M Router
18

www.netcommwireless.com
UM-00009 v1.7

^ **NetCommWireless** | [Status](#) | [Networking](#) | [Services](#) | [System](#) | [Help](#)

^ **System information**

System up time

00:02:54

Device version

Hardware version
1.0

Serial number
XXXXXXXXXXXXXX

Firmware version
VX.X.XX.X

Cellular module

Model
MC7304

Module firmware
05.05.26.00

IMEI
XXXXXXXXXXXXXX

^ **LAN**

IP
192.168.1.1 / 255.255.255.0

MAC address
00:60:64:D9:48:11

Ethernet port status #1
! Down

Ethernet port status #2
✔ Up / 1000 Mbps / FDX

^ **Cellular connection status**

SIM status
✔ SIM OK

Signal strength (dBm)
-74 dBm (High) ▬▬▬▬

Network registration status
Registered, home network

Operator selection
Automatic

Current operator
XXXXXXX

Roaming status
Not roaming

Allowed bands
All bands

Current band
LTE Band 3 - 1800Mhz

Coverage
LTE

^ **WAN**

Priority

✔ 1. wwan.0 [Link]

^ **External storage**

No media found

^ **WWAN connection status**

Profile name
Profile1 Show data usage

Status
Connected

Default profile
Yes

WWAN IP
10.102.40.104

DNS server
10.4.81.105
10.4.182.22

APN
XXXXXXX

Connection uptime
00:01:26

^ **WLAN AP status**

#	Status	Network Name (SSID)	MAC address	Channel	Network authentication	Station info
1	Enabled	NetComm 6457	00:60:64:D9:48:12	6	WPA2PSK	Station info

^ **USB-OTG**

Current status
Device mode

^ **SMS status**

Received message count
0

^ **Event notification**

Event count
0

^ **Advanced status**

Mobile country code
505

Mobile network code
XX

DC input voltage
12.26V

HSUPA category
6

HSDPA category
24

SIM ICCID
XXXXXXXXXXXXXXXXXX

Power input mode
DCJack

Tracking Area Code (TAC)
205F (8287)

IMSI
505013473874378

Cell ID
133256195

Channel number (UARFCN)
1275

Module PRIID Revision
05.00

Module PRIID PRI part number
9902976

PRI carrier
GENEU-4G

PRI config
GENEU-4G_005.010_000

Reference Signal Received Quality (RSRQ)
-8 dB

Reference Signal Received Power (RSRP)
-104 dBm

Packet service status
Attached

Figure 14 – NTC-140W-02 Status page

ITEM	DEFINITION
System information	
System up time	The current uptime of the router.
Board version	The hardware version of the router.
Serial Number	The serial number of the router.
Firmware version	The firmware version of the router
Model	The type of phone module and the firmware version of the module.
Module firmware	The firmware revision of the phone module.
IMEI	The International Mobile Station Equipment Identity number used to uniquely identify a mobile device.
MEID (NTC-140W-01 only)	The mobile equipment identifier (MEID) of the router, a unique code for identifying devices on a CDMA network.
LAN	
IP	The IP address and subnet mask of the router.
MAC Address	The MAC address of the router.
Ethernet Port Status	Displays the current status of the Ethernet port and its operating speed.
WAN	
Priority	Displays the priority of the available WAN connections.
External Storage	Lists the type and size of external storage (onboard/USB), if connected.
USB-OTG	Displays the current status of the USB-OTG port (Device or host mode)
Cellular connection status	
SIM Status	Displays the activation status of the SIM in the router.
Signal strength (dBm)	The current signal strength measured in dBm
Network registration status	The status of the router's registration for the current network.
Operator selection	The mode used to select an operator network.
Current operator	The current operator network in use.
Roaming status	The roaming status of the router.
Allowed bands	The bands to which the router may connect.
Current band	The current band being used by the router.
Coverage	The type of mobile coverage being received by the router.
WWAN Connection Status	
Profile name	The name of the active profile.
Status	The connection status of the active profile.
Default profile	Indicates whether the current profile in use is the default profile.
WWAN IP	The IP address assigned by the mobile broadband carrier network.
DNS server	The primary and secondary DNS servers for the WWAN connection.
APN	The Access Point Name currently in use.
Connection uptime	The length of time of the current mobile connection session.
WLAN status	
Status	Shows the current status of the wireless LAN network.
Network Name (SSID)	Shows the network name (SSID) of the wireless network.
Channel	Shows the channel that the wireless network is configured to operate on.
Network authentication	The type of security/encryption in use on the wireless network.
Station Info	Click the Station Info link to be taken to the station information page providing more information on the connected stations.
Advanced status (NTC-140W-01)	
MDN	The Mobile Directory Number of the router on the network.
SID / NID	The System ID and Network ID of the router.
DC input voltage	Displays the current voltage of the power input source provided via the DC Input jack

HSUPA category	Displays the HSUPA category (1-9) for the current uplink
HSDPA category	Displays the HSDPA category (1-8) for the current downlink.
SIM ICCID	The Integrated Circuit Card Identifier of the SIM card used with the router, a unique number up to 19 digits in length.
Power input mode	Displays the power source being used.
Pn index	The pseudo-random number index used in encrypting the mobile connection for RTT connections.
IMSI	The International mobile subscriber identity is a unique identifier of the user of a cellular network.
Channel number (UARFCN)	The channel number of the current cellular connection.
Module PRIID Revision	Module version used for customization.
Module PRIID PRI part number	The part number of the Module PRIID.
P-ESN	The pseudo-Electronic Serial Number.
PRL Version	The Preferred Roaming List. This is a list of carrier networks loaded on to the router which determines which prioritizes networks when roaming is enabled.
PRI carrier	The carrier network.
PRI config	Configuration file for the current carrier network.
MIP profile information	Displays various details about the profile used to connect to the broadband network.
Advanced status (NTC-140W-02)	
Mobile country code	The Mobile Country Code (MCC) of the router.
Mobile network code	The Mobile Network Code (MNC) of the router.
DC input voltage	Displays the current voltage of the power input source provided via the DC Input jack
HSUPA category	Displays the HSUPA category (1-9) for the current uplink
HSDPA category	Displays the HSDPA category (1-8) for the current downlink.
SIM ICCID	The Integrated Circuit Card Identifier of the SIM card used with the router, a unique number up to 19 digits in length.
Power input mode	Displays the power source being used.
Tracking Area Code (TAC)	Identifies a tracking area within a particular network.
IMSI	The International mobile subscriber identity is a unique identifier of the user of a cellular network.
Cell ID	A unique code that identifies the base station from within the location area of the current mobile network signal.
Channel number (UARFCN)	The channel number of the current cellular connection.
CID	Cellular configuration ID
Module PRIID Revision	Module version used for customization.
Module PRIID PRI part number	The part number of the Module PRIID.
PRI carrier	The carrier network.
PRI config	Configuration file for the current carrier network.
Reference Signal Received Quality (RSRQ)	RSRQ calculates signal quality taking into consideration the RSSI. It is calculated by $N \times \text{RSRP} / \text{RSSI}$ where N is the number of Physical Resources Blocks (PRBs) over which the RSSI is measured.
Reference Signal Received Power (RSRP)	A cell-specific reference signal used to determine RSRP.
Packet service status	Displays whether the packet service is attached or detached. When APN or username/password is changed, the device detaches and reattaches to the network.

Table 10 - Status page item details

Networking

The Networking section provides configuration options for Wireless WAN, LAN, Routing and VPN connectivity.

Wireless WAN

Data connection

The data connection page allows you to configure and enable/disable the connection profile. To access this page, click on the **Networking** menu, and under the **Wireless WAN** menu, select the **Data connection** item.

Profile name

Default	Status	APN	Username
Profile1	<input type="radio"/> ON OFF	otasn	
Profile2	<input checked="" type="radio"/> ON OFF	r.ispsn	
Profile3	<input type="radio"/> ON OFF	cinet.spcs	
Profile4	<input type="radio"/> ON OFF	r.ispsn	
Profile5	<input type="radio"/> ON OFF	Automatic	
Profile6	<input type="radio"/> ON OFF	Automatic	

Activation

Update type Device config. & PRL

Activate

Deactivation

MSL code

Deactivate/RTN

Roaming settings

Allow data roaming ON OFF

Save
Refresh

Figure 15 – Data connection settings

ITEM	DEFINITION
Profile name	
Default	Sets the corresponding profile to be the default gateway for all outbound traffic except traffic for which there are configured static route rules or profile routing settings.
Status	Toggles the corresponding profile on and off. Only one profile may be turned on at any time.
APN	The APN configured for the corresponding profile.
Username	The username used to log on to the corresponding APN.
Activation (only displayed when connecting to a carrier that supports the Open Mobile Alliance provisioning method)	
Update type	This drop down list is used to select the items that you would like to update when the Activate button is pressed.
Activate	The Activate button can be used to force the unit to activate on the carrier's network. A working SIM card must be inserted in the router to activate it. If a working SIM is inserted in the router, the router will automatically attempt to activate.
Deactivation (only displayed when connecting to a carrier that supports the Open Mobile Alliance provisioning method)	
MSL code	The Master Subsidy Lock (MSL) code is provided by your carrier and is used to de-activate the device from the carrier's network.
Deactivate/RTN	When the correct MSL code has been entered, press the Deactivate/RTN button to deactivate the router.
Roaming settings	
Allow data roaming	When set to ON , the router will allow local devices to access the Wireless WAN network when it is roaming onto a foreign network. When set to OFF , the router will deny network access to data services when roaming onto a foreign network. This setting is OFF by default. Note that additional costs may apply when using roaming data services.

Table 11 - Data connection item details

Activating the router on the carrier's network (only on units with module firmware that supports the Open Mobile Alliance provisioning method)

If your NTC-140W comes with a module firmware version for a specific carrier network that requires activation, you can activate the router by booting the router with the carrier's SIM inserted. The router detects the inserted SIM and automatically activates the router on the carrier's network.

De-activating the router from the carrier's network (only on units with module firmware that supports the Open Mobile Alliance provisioning method)

To de-activate the unit, you must enter the Master Subsidy Lock (MSL) code and press the Deactivate button. This code is provided by your carrier. Before de-activating the router on the network, remove the SIM card from the router to prevent it from automatically activating again.

Connecting to the mobile broadband network

The router supports the configuration of up to six APN profiles; these profiles allow you to configure the settings that the router will use to connect to the broadband network and switch easily between different connection settings.

Manually configuring a connection profile

To manually configure a connection profile:

1. Click the **Edit** button corresponding to the Profile that you wish to modify. The data connection profile settings page is displayed.

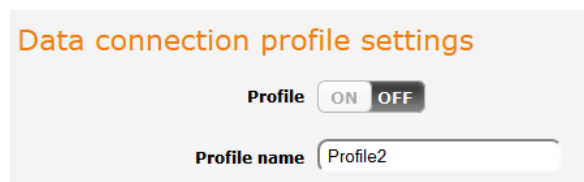
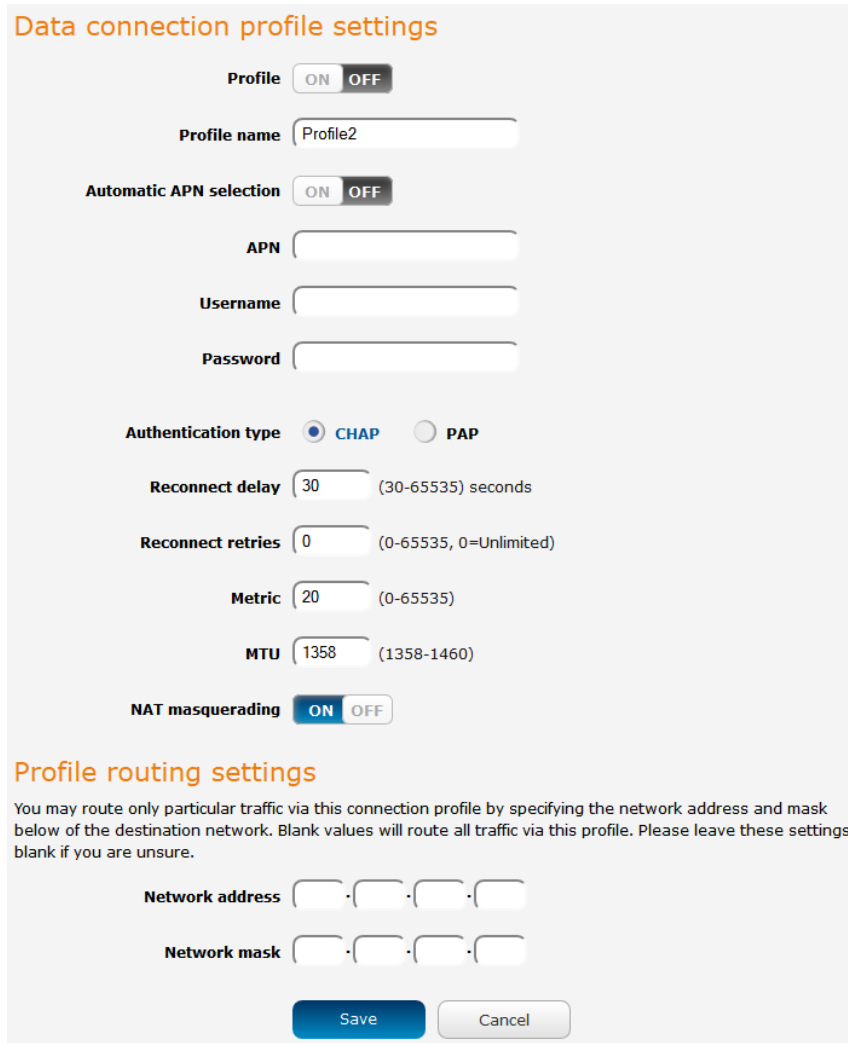

Figure 16 - Data connection profile settings

- Click the **Profile** toggle key to turn the profile on. Additional settings appear.



Data connection profile settings

Profile ON OFF

Profile name

Automatic APN selection ON OFF

APN

Username

Password

Authentication type CHAP PAP

Reconnect delay (30-65535) seconds

Reconnect retries (0-65535, 0=Unlimited)

Metric (0-65535)

MTU (1358-1460)

NAT masquerading ON OFF

Profile routing settings

You may route only particular traffic via this connection profile by specifying the network address and mask below of the destination network. Blank values will route all traffic via this profile. Please leave these settings blank if you are unsure.

Network address . . .

Network mask . . .

Figure 17 - Data connection settings - Profile turned on

- In the **Profile name** field, enter a name for the profile. This name is only used to identify the profile on the router.
- Ensure that the **Automatic APN selection** toggle key is set to off. If it is not, click it to toggle it to the off position.
- In the **APN** field, enter the APN Name (Access Point Name) and if required, use the **Username** and **Password** fields to enter your login credentials. Note that the APN and username fields have a limit of 81 characters.
- Next to **Authentication** type, select either CHAP or PAP depending on the type of authentication used by your provider.
- The **Reconnect delay** field specifies the number of seconds to wait between connection attempts. The default setting of 30 seconds is sufficient in most cases but you may modify it to wait up to 65535 seconds if you wish.
- The **Reconnect retries** field specifies the number of times to attempt a network connection if the router fails to establish a connection. It is set to 0 by default which causes the router to attempt to reconnect indefinitely.
- The **Metric** value is used by router to prioritise routes (if multiple are available) and is set to 20 by default. This value is sufficient in most cases but you may modify it if you are aware of the effect your changes will have on the service.
- The **MTU** field allows you to modify the Maximum Transmission Unit used on the connection. Do not change this unless instructed to by your carrier.
- Use the **NAT Masquerading** toggle key to turn NAT Masquerading on or off. NAT masquerading, also known simply as NAT is a common routing feature which allows multiple LAN devices to appear as a single WAN IP via network address translation. In this mode, the router modifies network traffic sent and received to inform remote computers on the internet that packets originating from a machine behind the router actually originated from the WAN IP address of the router's internal NAT IP address. This may be disabled if a framed route configuration is required and local devices require WAN IP addresses.
- Click the **Save** button when you have finished entering the profile details.

Confirming a successful connection

After configuring the packet data session, and ensuring that it is enabled, click on the Status menu item at the top of the page to return to the Status page. When there is a mobile broadband connection, the **WWAN** section is expanded showing the details of the connection and the Status field displays **Connected**. To see details on the connected session, you can click the **Show data usage** button.

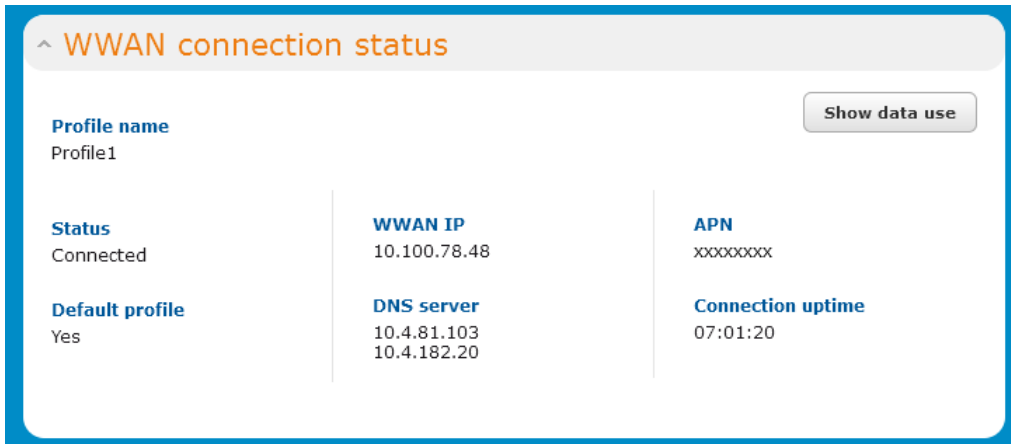

^ WWAN connection status		
Profile name Profile1		Show data use
Status Connected	WWAN IP 10.100.78.48	APN xxxxxxx
Default profile Yes	DNS server 10.4.81.103 10.4.182.20	Connection uptime 07:01:20

Figure 18 - WWAN connection status section

Connect on demand

The Connect on demand feature keeps the Packet Data Protocol (PDP) context deactivated by default while making it appear to locally connected devices that the router has a permanent connection to the mobile broadband network. When a packet of interest arrives or an SMS wake-up command is received, the router attempts to establish a mobile broadband data connection. When the data connection is established, the router monitors traffic and terminates the link when it is idle.



Note: When interesting packets arrive, the recovery time for the wireless WAN connection is approximately 20-30 seconds.

Configuring Connect on demand

To configure Connect on demand:

1. Click the **Networking** menu item from the top menu bar.
2. On the **Connect on demand** page, click the **Connect on demand** toggle key so that it is **ON**. Extra options appear. See the following sub-sections for further instructions.

Connect on demand

The connect on demand feature keeps the PDP context deactivated by default while making it appear that the router has permanent connection to WWAN and locally connected devices. When interesting packets arrive or an SMS wake-up command is received, the router will attempt to establish a WWAN data connection. The router will monitor traffic once the data connection is established and will terminate it when the link is idle.

Connect on demand ON OFF

Selected profile Profile 1

Data activity triggered connection

Connect only when traffic appears to these UDP/TCP destination ports. You can specify multiple ports by separating them with a comma (eg 21, 23, 53).

Enable dial port filter ON OFF

Connect on data activity except when activity matches these IP protocols

Ignore ICMP ON OFF

Ignore TCP ON OFF

Ignore UDP ON OFF

on data activity except when activity matches these applications

Ignore DNS ON OFF

Ignore NTP ON OFF

Ignore Microsoft network awareness (NCSI) traffic ON OFF

Connect and disconnect timers Periodic connect schedule

On data activity, stay online for at least 20 minutes

After connecting, stay online for at least 20 minutes

After hanging up, don't redial for 5 seconds

Disconnect regardless of traffic after never

Connect regularly, every never

Randomize connect frequency by up to never

Verbose logging configuration

Log all matched activity to the system log ON OFF

Online / Offline control

Connection status Disabled

Figure 19 - Connect on demand configuration options

Setting the router to dial a connection when traffic is detected on specific ports

In some situations, you may wish to have the internet connection disabled except at times when outbound traffic to a particular external host's port or group of ports is sent to the router. To use this feature, click **Enable dial port filter** and enter the port number or list of port numbers separated by commas. When you select this option, all outbound ICMP/TCP/UDP packets to any remote host on the specified port(s) will trigger the connection to dial. Note that when this feature is enabled, the options to ignore specific packet types are not available.

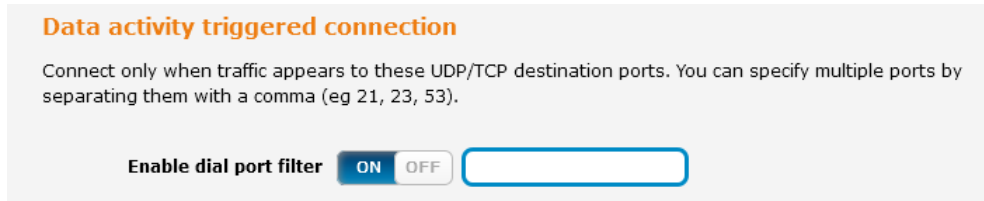

Figure 20 – Connect on demand - Data activity triggered connection

You can allow Microsoft network awareness (NCSI) traffic through but if you prefer that they do not trigger the connection, click the **Ignore Microsoft network awareness (NCSI) traffic** toggle key to set it to **ON**.

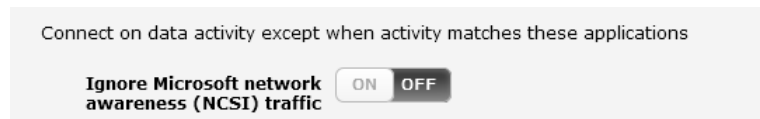

Figure 21 - Connect on demand - Ignore NCSI traffic

Excluding certain packet types from triggering the connection to dial

Depending on your environment, you might prefer to exclude certain types of traffic passing through the router from triggering the data connection. You can tell the router to ignore outbound TCP, UDP or ICMP packets. When any of these options are checked the router will not dial a connection when that type of outbound destined data packet reaches the router from a locally connected device.



Figure 22 – Connect on demand - Excluding IP protocols

Excluding certain application types from triggering the connection to dial

Some devices may generate general traffic as a part of normal operation which you may not want to trigger the data connection. You can set the router to ignore Domain Name System (DNS), Network Time Protocol (NTP) or Microsoft network awareness (NCSI) traffic from devices behind the router. When you check the box for these options, it tells the router to ignore the request from that application type and will not dial a connection when this data type is received.



Figure 23 - Connect on demand - Excluding application types

Setting timers for connection and disconnection

The router has a number of timer settings which let you determine when a connection is dialled and when it is disconnected.

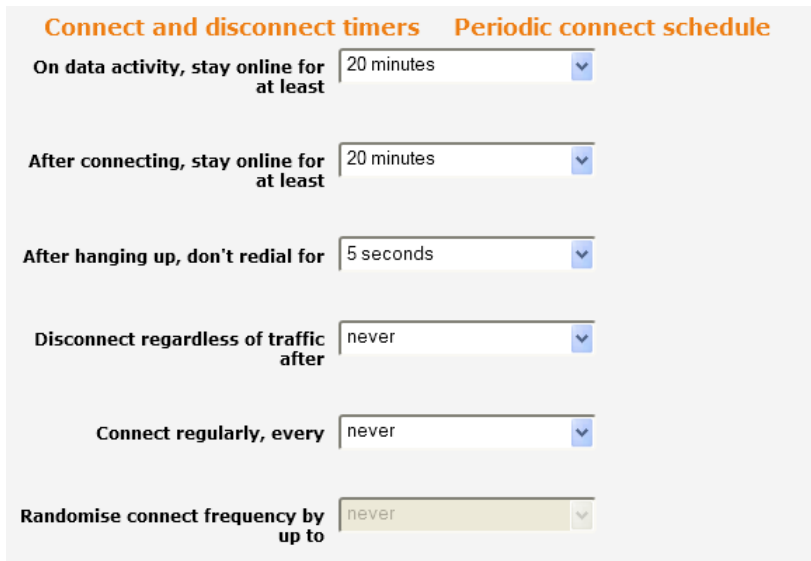

Connect and disconnect timers **Periodic connect schedule**

On data activity, stay online for at least 20 minutes

After connecting, stay online for at least 20 minutes

After hanging up, don't redial for 5 seconds

Disconnect regardless of traffic after never

Connect regularly, every never

Randomise connect frequency by up to never

Figure 24 – Connect on demand - Connect and disconnect timers

OPTION	DESCRIPTION
On data activity, stay online for at least	When traffic as per the configured settings above appear, the router will either continue to stay online, or dial a connection and will not disconnect it for the specified time period (min. 1 minute, max. 1 hour). This timer is continuously reset throughout the duration of a dial-up session, whenever data activity is detected matching the rules above.
After connecting, stay online for at least	This timer configures the router to not hang-up the connection for the specified time period after initially dialling the connection. This setting cannot be less than the keep online period above. This timer affects the connection only once per dial up session, at the beginning of the session.
After hanging up, don't redial for	After a connection has been disconnected, you can tell the router to rest for a period of time before re-dialling.
Disconnect regardless of traffic after	Forces the router to disconnect the connection regardless of the traffic passing through it. The default setting is <i>never</i> .
Connect regularly, every / Randomise connect frequency by up to	<p>If you want to have the router dial a connection at regular intervals, use Connect regularly, every to specify the interval between dials. Setting this to <i>never</i> effectively disables this option.</p> <p>The router also features the ability to randomise the time at which the first dial action is performed. This is useful in situations such as where you have numerous routers in an area where a power outage has occurred. Setting a random dial time helps to reduce network congestion when all the routers are powered on so they do not all try to connect simultaneously.</p> <p>When Connect regularly, every is set to at least 2 minutes, you are able to configure the router to randomise the time it begins to dial. The randomised dial timer only affects the initial dial after the unit powers on or after the settings are saved. For example, if you configure the router to dial every 2 minutes with a randomised dial starting time of 1 minute, the router waits for the Connect regularly, every time (2 minutes) and then randomly selects a time less than or equal to the Randomise connect frequency by up to time (1 minute). After the randomly selected time has elapsed, the router dials the connection. After the first dial, the router dials the connection every 2 minutes, ignoring the Randomise connect frequency by up to time.</p>

Table 12 - Connect on demand - Connect and disconnect timers descriptions

Verbose mode

The router provides the option of logging all the data activity which matches the settings for the Connect on demand feature for advanced troubleshooting purposes. To enable the logging of the Connect on demand feature, click the **Enable verbose mode** toggle key to switch it **ON**. See the System log section for more information.

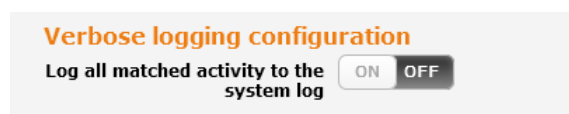

Verbose logging configuration

Log all matched activity to the system log ON OFF

Figure 25 – Connect on demand - Verbose logging configuration

Manually connecting/disconnecting

There may be times when you need to either force a connection to be made or force a disconnection manually. You can use the **Manual connect** and **Manual disconnect** buttons to do this whenever necessary. The online status of the connection is displayed above the buttons.

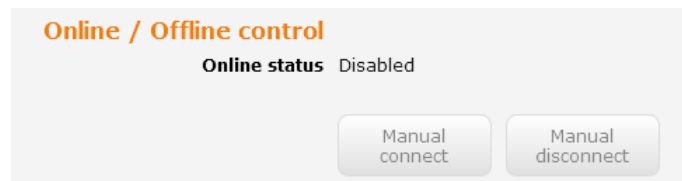

Figure 26 - Connect on demand - Online/Offline control

When you have finished configuring the options for the Connect on demand feature, click the **Save** button at the bottom to save your changes.

SMS Wake up

The router can also be woken up by means of an SMS message using the SMS diagnostics feature by sending an executable wakeup command via SMS. See the [Diagnostics](#) section for details on using the SMS Wake up function.

SIM management

The SIM management page allows you to specify the primary SIM to use in the case where you have a soldered down SIM card and a SIM inserted into the SIM tray. To change the preference of the SIMs, use the arrow button to the right of SIM2 to switch priorities and click the **Save** button.

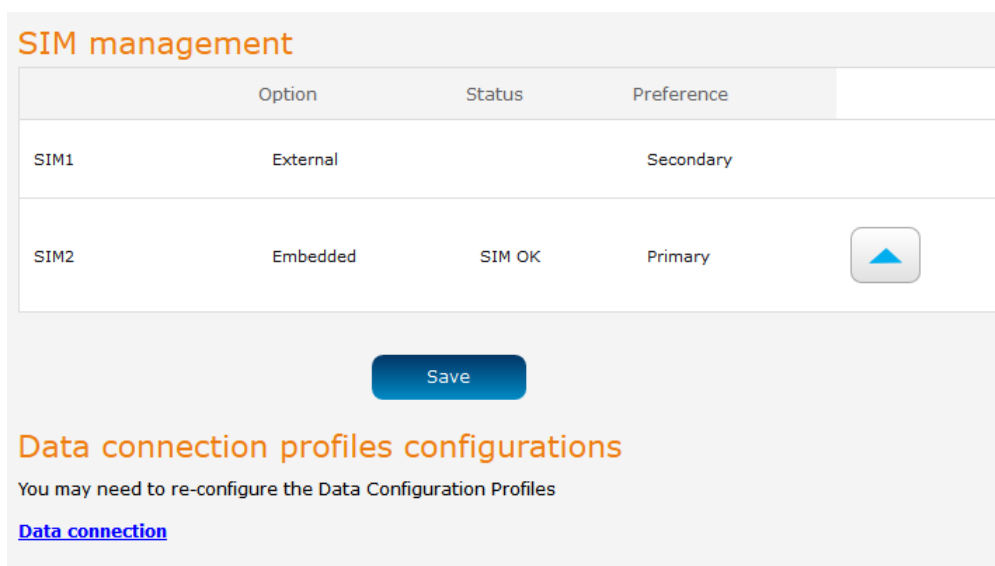

Figure 27 – SIM Management

Operator settings

The Operator settings page enables you to select which frequency band you will use for your connection and enables you to scan for available network operators in your area.

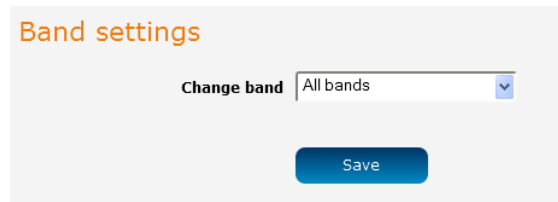

Figure 28 - Band settings



Note: In order to change the operator's band settings, the data connection must be disabled. When you access this page, you are prompted to disable the data connection if it is already active.

You may want to do this if you're using the router in a country with multiple frequency networks that may not all support High Speed Packet Access (HSPA). You can select the router to only connect on the network frequencies that suit your requirements.

Use the **Change band** drop down list to select the band you wish to use.

The following band settings options are available:

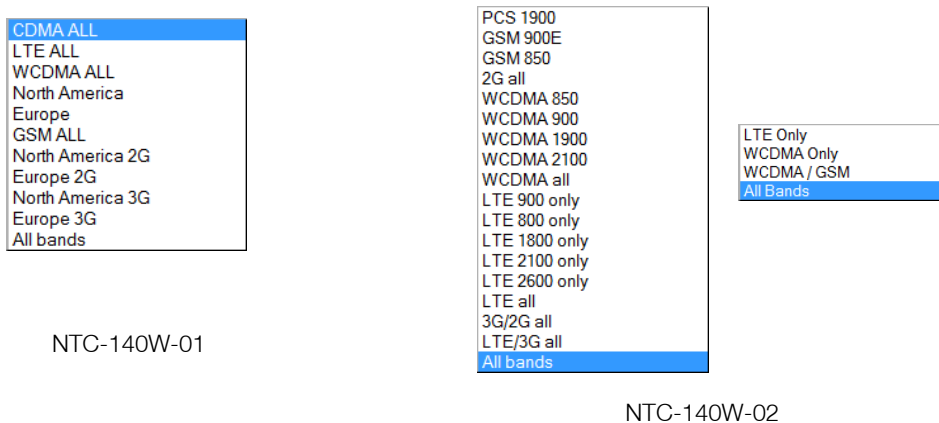

Note: The available bands may vary depending on your variant of the product.

It is not necessary to change the default setting of **All bands** in most cases. In fact, locking to a particular band can cause connection difficulties if the device is moved to a location where the forced band selection is no longer available.

When **All bands** is selected, the router attempts to find the most suitable band based on the available networks for the inserted SIM card.

The "2G all", "WCDMA all", "LTE all", "3G/2G all" and "LTE/3G all" options allow you to force the device to lock to those particular networks only.

Click the **Save** button to save and apply your selection.

Operator settings

The operator settings feature allows you perform a scan of available networks, and to optionally lock to a particular network returned by the network scan. To scan for available networks, set the **Select operator mode** from automatic to **Manual** then click the scan button. This operation can take a few minutes and requires that the packet data session be disconnected prior to scanning.

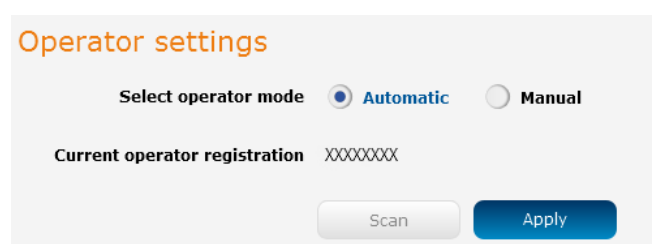

Figure 29 - Operator settings

A list of the detected cellular service carriers in your area is displayed.

	Operator name list	MCC	MNC	Operator status	Network type
<input type="radio"/>	Telstra	505	01	Available	UMTS (3G)
<input type="radio"/>	Telstra	505	01	Available	GSM (2G)
<input checked="" type="radio"/>	Telstra	505	01	Current	LTE (4G)
<input type="radio"/>	vodafone AU	505	03	Forbidden	UMTS (3G)
<input type="radio"/>	YES OPTUS	505	02	Forbidden	GSM (2G)
<input type="radio"/>	YES OPTUS	505	02	Forbidden	LTE (4G)
<input type="radio"/>	vodafone AU	505	03	Forbidden	GSM (2G)
<input type="radio"/>	YES OPTUS	505	02	Forbidden	UMTS (3G)

Figure 30 - Detected operator list



Note: Certain module firmware versions may not allow forbidden operators to be selected.

Select the most appropriate service from the list shown and click **Apply**.

When **Select operator mode** is set to **Automatic**, the router selects the most appropriate operator based on the inserted SIM card. This is the default option and is sufficient for most users.

SIM security settings

The SIM security settings page can be used for authenticating SIM cards that have been configured with a security PIN.

Unlocking a PIN locked SIM

If the SIM card is locked, you will receive a notice when you access the Status page after which you will be directed to the PIN settings page to enter the PIN. The PIN settings page lists the status of the SIM at the top of the page.

If you are not redirected to the PIN settings page, to unlock the SIM:

- a) Click on the **Networking** menu from the top menu bar, and then click **SIM security settings**.

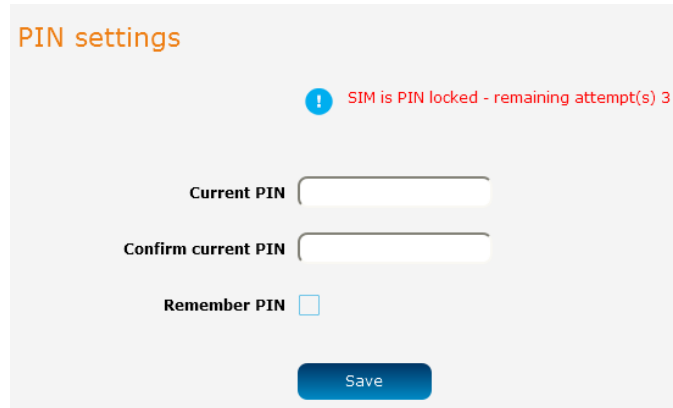

PIN settings

! SIM is PIN locked - remaining attempt(s) 3

Current PIN

Confirm current PIN

Remember PIN

Save

Figure 31 - SIM security settings - SIM PIN locked

- b) Enter the PIN in the **Current PIN** field and then enter it again in the **Confirm current PIN** field to confirm the PIN.
- c) If you are placing the router in a remote, unattended location, you may wish to check the **Remember PIN** option. This feature allows the router to automatically send the PIN to the SIM each time the SIM asks for it (usually at power up). This enables the SIM to be PIN locked (to prevent unauthorised re-use of the SIM elsewhere), while still allowing the router to connect to the cellular service.

When this feature is enabled, the PIN you enter when setting the **Remember PIN** feature is encrypted and stored locally on the router. The next time the SIM asks the router for the PIN, the router decrypts the PIN and automatically sends it to the SIM without user intervention.

When this feature is disabled and the SIM is PIN locked and the PIN must be manually entered via the router's configuration interface. In situations where the router will be unattended, this is not desirable.



Note: Select **Remember PIN** if you do not want to enter the PIN code each time the SIM is inserted.

- d) Click the **Save** button. If successful, the router displays the following screen:

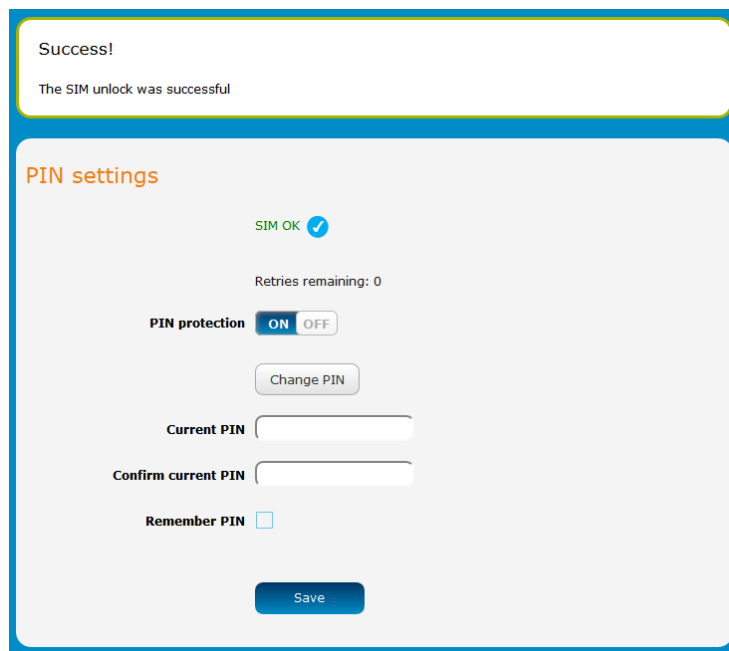

Success!
The SIM unlock was successful

PIN settings

SIM OK ✔

Retries remaining: 0

PIN protection **ON** OFF

Change PIN

Current PIN

Confirm current PIN

Remember PIN

Save

Figure 32 - SIM security settings - SIM unlock successful

Enabling/Disabling SIM PIN protection

The security PIN protection can be turned on or off using the **PIN protection** toggle key.

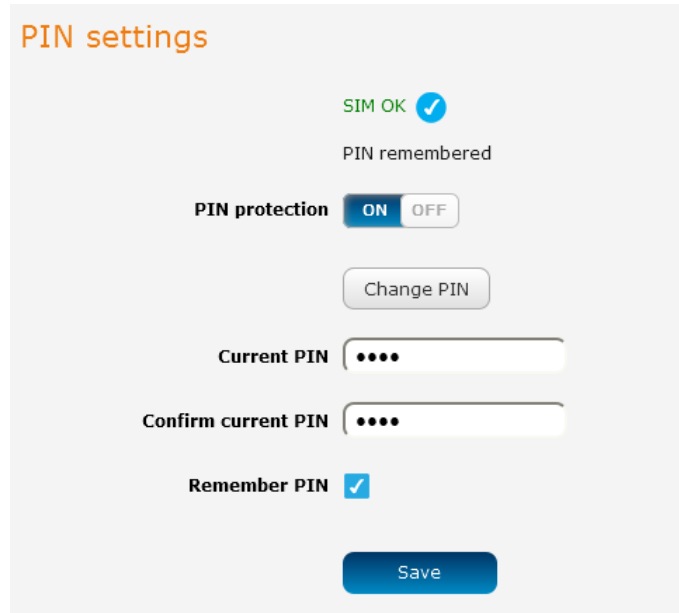

Figure 33 - PIN Settings

Changing the SIM PIN code

If you would like to change the PIN, click the **Change PIN** button and enter the current PIN into the **Current PIN** and **Confirm current PIN** fields, then enter the desired PIN into the **New PIN** and **Confirm new PIN** fields and click the **Save** button.

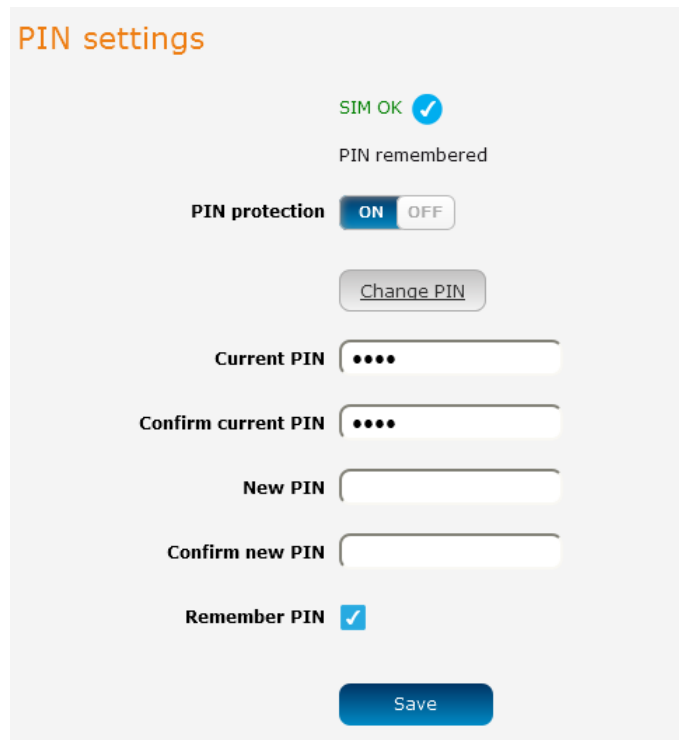

Figure 34 - PIN settings - Change PIN

When the PIN has been changed successfully, the following screen is displayed:

Success!

Your settings have been changed successfully

PIN settings

SIM OK

PIN remembered

PIN protection ON OFF

Current PIN

Confirm current PIN

Remember PIN

Figure 35 - SIM security settings – PIN unlock successful

Unlocking a PUK locked SIM

After three incorrect attempts at entering the PIN, the SIM card becomes PUK (Personal Unblocking Key) locked and you are requested to enter a PUK code to unlock it.



Note: To obtain the PUK unlock code, you must contact your service provider.

You will be issued a PUK to enable you to unlock the SIM and enter a new PIN. Enter the new PIN and PUK codes. Click the **Save** button when you have finished entering the new PIN and PUK codes.

Oops, something went wrong...

Your SIM is PUK locked now. Please enter the PUK code to unlock. You have 10 remaining attempt(s).

PIN settings

! SIM is PUK locked

Current PIN

Confirm current PIN

PUK

Confirm PUK

Remember PIN

Figure 36 - SIM security - SIM PUK locked

LAN

LAN configuration

The LAN configuration page is used to configure the LAN settings of the router and to enable or disable DNS Masquerading. To access the LAN configuration page, click on the **Networking** menu at the top of the screen, then click on the **LAN** menu on the left.

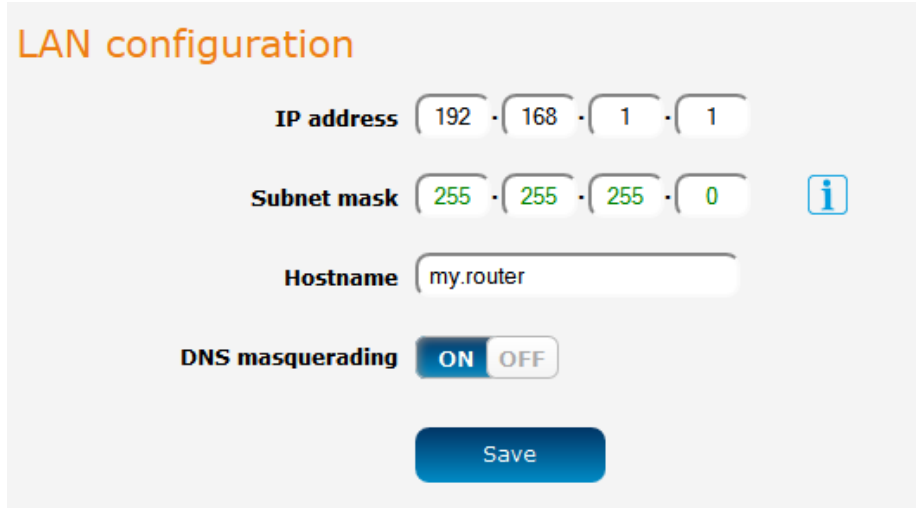

The screenshot shows the 'LAN configuration' interface. It features four main sections: 'IP address' with four input boxes containing '192', '168', '1', and '1'; 'Subnet mask' with four input boxes containing '255', '255', '255', and '0', accompanied by an information icon; 'Hostname' with a text input field containing 'my.router'; and 'DNS masquerading' with a toggle switch currently set to 'ON'. A blue 'Save' button is positioned at the bottom center.

Figure 37 – LAN configuration settings

The default IP of the LAN port is 192.168.1.1 with subnet mask 255.255.255.0. To change the IP address or Subnet mask, enter the new IP Address and/or Subnet mask and click the **Save** button.



Note: If you change the IP address, remember to reboot the router and enter the new IP address into your browser address bar.

DNS masquerading

DNS masquerading allows the router to proxy DNS requests from LAN clients to dynamically assigned DNS servers. When enabled, clients on the router's LAN can then use the router as a DNS server without needing to know the dynamically assigned cellular network DNS servers.

With DNS masquerading **ON**, the DHCP server embedded in the NTC-140W Series router hands out its own IP address (e.g. 192.168.1.1) as the DNS server address to LAN clients. The downstream clients then send DNS requests to the NTC-140W Series router which proxies them to the upstream DNS servers.

With DNS masquerading **OFF**, the DHCP server hands out the upstream DNS server IP addresses to downstream clients directly, so that downstream clients send DNS requests directly to the upstream DNS servers without being proxied by the NTC-140W Series router.

You may also override the DNS Masquerading option by specifying custom DNS Server IP addresses in the DHCP Server configuration mentioned in the next section of this guide. In this case the DHCP server assigns downstream devices the manually configured addresses and the DNS Masquerading option is ignored.

In most cases, it is not necessary to disable DNS masquerading but if you need to, click the **DNS masquerading** toggle key to turn it **OFF** and then click the **Save** button.

DHCP

The DHCP page is used to adjust the settings used by the router's built in DHCP Server which assigns IP addresses to locally connected devices. To access the LAN configuration page, click on the **Networking** menu at the top of the screen, click on the **LAN** menu on the left then select the **DHCP** menu item.

DHCP relay configuration

In advanced networks configurations where the NTC-140W Series router should not be responsible for DHCP assignment, but instead an existing DHCP server is located on the Wireless WAN or LAN connections, the clients behind the NTC-140W Series router are able to communicate with the DHCP server when DHCP relay is enabled. This enables the NTC-140W Series router to accept client broadcast messages and to forward them onto another subnet.

To configure the router to act as a DHCP relay agent click the **DHCP relay** toggle key to turn it **ON** and enter the DHCP server address into the **DHCP server address** field. DHCP relay is disabled by default.

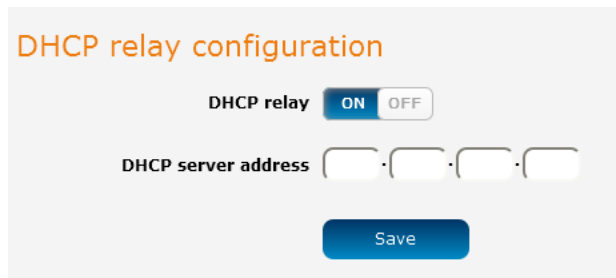

The screenshot shows the 'DHCP relay configuration' section. At the top, there is a title 'DHCP relay configuration' in orange. Below it is a 'DHCP relay' toggle switch currently set to 'ON'. Underneath is a 'DHCP server address' field with four input boxes for IP address segments. At the bottom is a blue 'Save' button.

Figure 38 – DHCP relay configuration

DHCP configuration

You can manually set the start and end address range to be used to automatically assign addresses within, the lease time of the assigned address, the default domain name suffix, primary and secondary DNS server, the primary and secondary WINS server, as well as the advanced DHCP settings such as NTP, TFTP and Option 150/Option 160 (VoIP options).

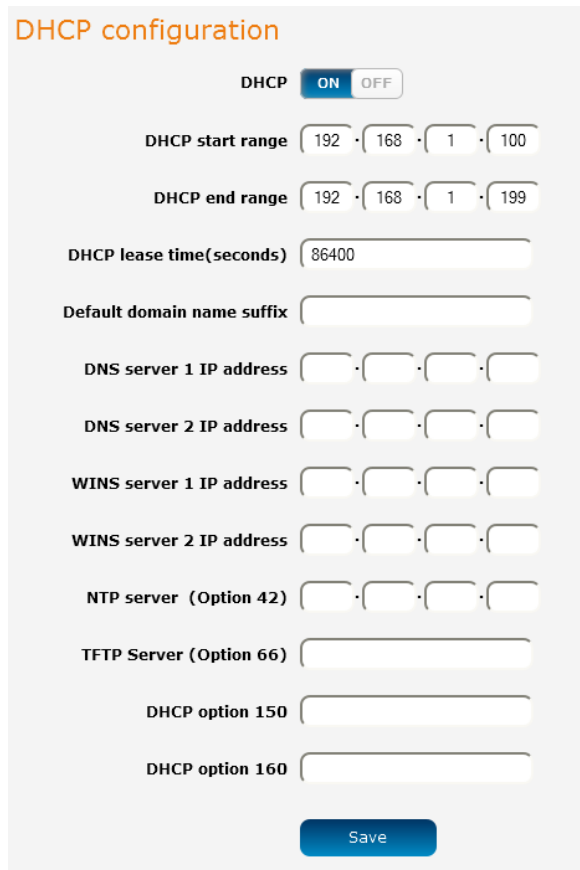

The screenshot shows the 'DHCP configuration' section. At the top, there is a title 'DHCP configuration' in orange. Below it is a 'DHCP' toggle switch currently set to 'ON'. The configuration fields include: 'DHCP start range' (192, 168, 1, 100), 'DHCP end range' (192, 168, 1, 199), 'DHCP lease time(seconds)' (86400), 'Default domain name suffix' (empty), 'DNS server 1 IP address', 'DNS server 2 IP address', 'WINS server 1 IP address', 'WINS server 2 IP address', 'NTP server (Option 42)', 'TFTP Server (Option 66)', 'DHCP option 150', and 'DHCP option 160'. A blue 'Save' button is at the bottom.

Figure 39 - DHCP configuration

OPTION	DESCRIPTION
DHCP start range	Sets the first IP address of the DHCP range
DHCP end range	Sets the last IP address of the DHCP range
DHCP lease time (seconds)	The length of time in seconds that DHCP allocated IP addresses are valid
Default domain name suffix	Specifies the default domain name suffix for the DHCP clients. A domain name suffix enables users to access a local server, for example, server1, without typing the full domain name server1.domain.com
DNS server 1 IP address	Specifies the primary DNS (Domain Name System) server's IP address.
DNS server 2 IP address	Specifies the secondary DNS (Domain Name System) server's IP address.
WINS server 1 IP address	Specifies the primary WINS (Windows Internet Name Service) server IP address
WINS server 2 IP address	Specifies the secondary WINS (Windows Internet Name Service) server IP address
NTP server (Option 42)	Specifies the IP address of the NTP (Network Time Protocol) server
TFTP Server (Option 66)	Specifies the TFTP (Trivial File Transfer Protocol) server
DHCP option 150	This is used to configure Cisco IP phones. When a Cisco IP phone starts, if it is not pre-configured with the IP address and TFTP address, it sends a request to the DHCP server to obtain this information. Specify the string which will be sent as a reply to the option 150 request.
DHCP option 160	This is used to configure Polycom IP phones. When a Polycom IP phone starts, if it is not pre-configured with the IP address and TFTP address, it sends a request to the DHCP server to obtain this information. Specify the string which will be sent as a reply to the option 160 request.

Enter the desired DHCP options and click the **Save** button.

Address reservation list

DHCP clients are dynamically assigned an IP address as they connect, but you can reserve an address for a particular device using the address reservation list.

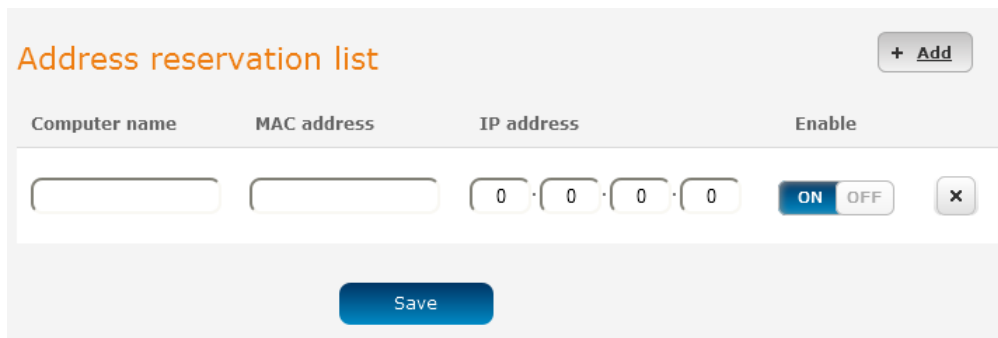

The screenshot shows a web interface titled "Address reservation list". At the top right is a "+ Add" button. Below the title is a table with four columns: "Computer name", "MAC address", "IP address", and "Enable". The "IP address" column contains four input boxes, each with the number "0". To the right of the IP address boxes is a toggle switch labeled "ON" and "OFF", currently set to "ON". There is also a small "x" icon in a box to the right of the toggle. At the bottom center of the form is a blue "Save" button.

Figure 40 – DHCP – Address reservation list

To add a device to the address reservation list:

1. Click the **+Add** button.
2. In the **Computer Name** field enter a name for the device.
3. In the **MAC Address** field, enter the device's MAC address.
4. In the **IP Address** fields, enter the IP address that you wish to reserve for the device.
5. If the **Enable** toggle key is not set to **ON**, click it to switch it to the **ON** position.
6. Click the **Save** button to save the settings.

Dynamic DHCP client list

The Dynamic DHCP client list displays a list of the DHCP clients. If you want to reserve the current IP address for future use, click the **Clone** button and the details will be copied to the address reservation list fields. Remember to click the **Save** button under the **Address reservation list** section to confirm the configuration.

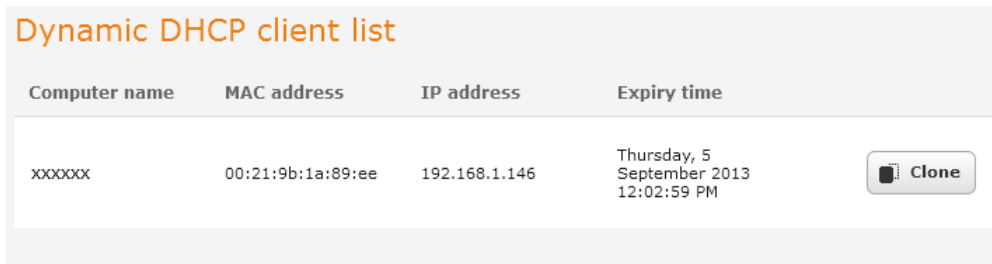

The screenshot shows a web interface titled "Dynamic DHCP client list". It contains a table with the following columns: "Computer name", "MAC address", "IP address", and "Expiry time". A single row of data is visible, with a "Clone" button to its right.

Computer name	MAC address	IP address	Expiry time	
xxxxxx	00:21:9b:1a:89:ee	192.168.1.146	Thursday, 5 September 2013 12:02:59 PM	<input type="button" value="Clone"/>

Figure 41 - Dynamic DHCP client list

Wireless settings

The Wireless settings pages allow you to configure the WiFi settings of the router. The NTC-140W is capable of running both access point and wireless client modes simultaneously, however, they must both use the same channel number.

AP basic

The AP basic page provides options such as for turning the WiFi access point on or off, modes of operation, and frequency settings. Additionally, a list of configured wireless networks is displayed along with their settings and status. To access the AP basic page, click on the **Networking** menu at the top of the screen, click on the **Wireless settings** menu on the left then select the **AP basic** menu item.

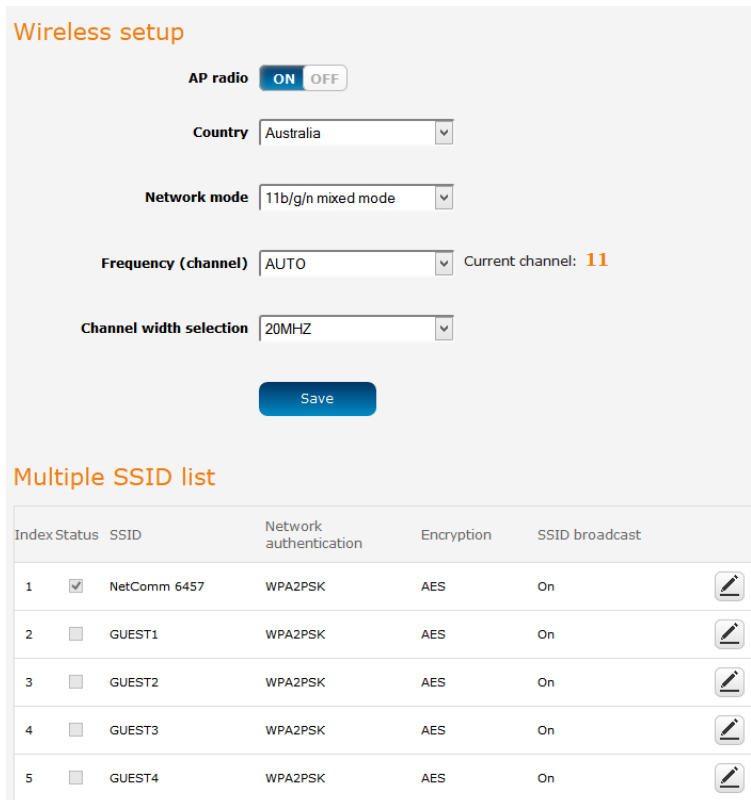

Wireless setup

AP radio ON OFF

Country

Network mode

Frequency (channel) Current channel: **11**

Channel width selection

Multiple SSID list

Index	Status	SSID	Network authentication	Encryption	SSID broadcast	
1	<input checked="" type="checkbox"/>	NetComm 6457	WPA2PSK	AES	On	
2	<input type="checkbox"/>	GUEST1	WPA2PSK	AES	On	
3	<input type="checkbox"/>	GUEST2	WPA2PSK	AES	On	
4	<input type="checkbox"/>	GUEST3	WPA2PSK	AES	On	
5	<input type="checkbox"/>	GUEST4	WPA2PSK	AES	On	

Figure 42 - Wireless Settings - Basic

OPTION	DEFINITION
Wireless setup	
AP radio on/off	The WiFi access point is turned on by default. Changing this option to OFF will turn OFF the wireless access point functionality of the NTC-140W and you will not be able to connect to it with a wireless client.
Country	Select the country you are operating the NTC-140W in.
Network mode	There are 6 possible network modes to use depending on the capability of your devices' wireless network cards. Each mode represents one or more wireless network protocols. Each wireless device will be capable of receiving some but possibly not all of wireless broadcast protocol types. They are: <ul style="list-style-type: none"> • 802.11b/g/n mixed mode. • 802.11b only. • 802.11g only. • 802.11n only. • 802.11b/g/n mixed mode.
Frequency (Channel)	Select the wireless channel of the access point that the wireless signal will broadcast on.
Channel width selection	A higher channel width typically results in higher throughput, however, interference can lead to reduced performance. The 20 MHz channel width also allows legacy devices to be used.
Multiple SSID List	
Index	A number assigned to the SSID used for easy reference.
Status	When checked, the network is active.
SSID	The name of the wireless network.
Network Authentication	The type of wireless network security in use.
Encryption	The type of encryption in use on the network. This may be AES or TKIP
SSID Broadcast	Displays whether the network is broadcasting the SSID. If it is broadcasting, the network will be discoverable by clients. If SSID Broadcast is off, clients must know the SSID in order to join the network.

Table 13 - Wireless Configuration - Basic Configuration Items

Configuring wireless network profiles

By default, a single wireless network is configured and active. You can enable/disable or adjust the settings of any profile by clicking on the Edit button for the appropriate profile. When you select the Edit button of a profile, the SSID and security settings page is displayed.

SSID and security settings

The SSID and security settings page is where you can configure the security settings for the chosen wireless network. The table below provides a description of each of the settings.

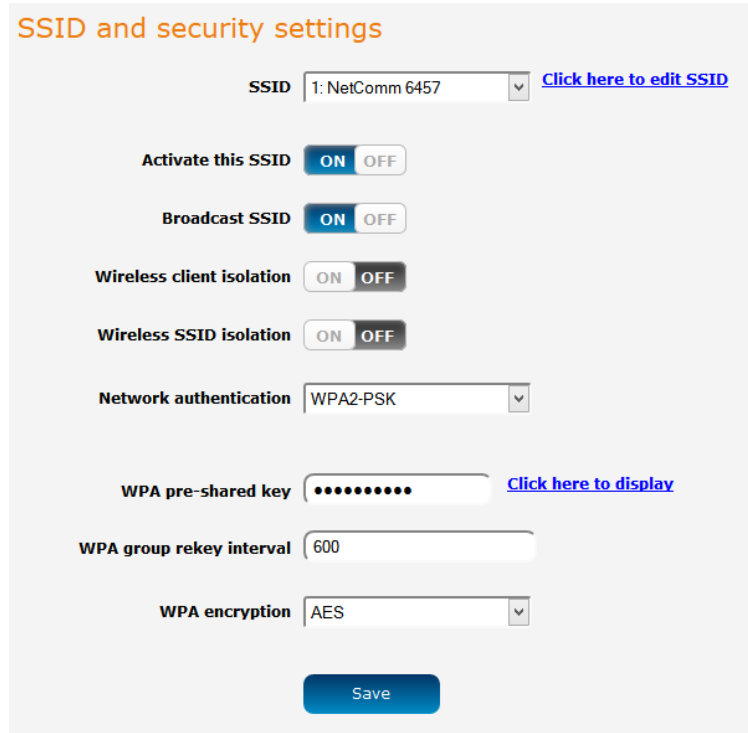

Figure 43 - Wireless Settings – SSID and Security Settings

OPTION	DEFINITION
SSID	The SSID (Service Set Identifier) or Network Name in use for the wireless network.
Activate this SSID	Enables or disables the network selected in the SSID drop down list.
Broadcast SSID	Toggles whether the router broadcasts the SSID or whether it is hidden from wireless network scans.
Wireless client isolation	When wireless client isolation is enabled, clients connected to the same network (SSID) are unable to communicate with other clients on the same network. If Wireless client isolation is enabled and Wireless SSID isolation is disabled, clients in one network will still be able to access clients in another network.
Wireless SSID isolation	When wireless SSID isolation is enabled, clients in one network (SSID) are unable to communicate with clients in other networks.
Network Authentication	The wireless security settings. See below for in depth analysis.
WPA pre-shared key	The wireless security key or wireless password.
WPA group rekey interval	The time in seconds before a new key is generated.
WPA encryption	The type of WPA encryption. Options include AES or TKIP

Table 14 - Wireless Settings – SSID and Security Settings

AP advanced

The advanced wireless configuration page allows you to modify advanced wireless access point settings of your router. These settings are set to optimal settings for most situations and should not be changed unless you are aware of the effect that your changes will have. To access the AP advanced page, click on the **Networking** menu at the top of the screen, click on the **Wireless settings** menu on the left then select the **AP advanced** menu item.

Advanced wireless settings

This page allows you to modify the advanced wireless settings for your router. These settings should not be changed unless you are aware of what effect they will have.

Maximum number of connected clients (range 1 - 127, default 31) i

Client idle timeout sec (range 60 - 600, default 300)

Beacon interval ms (range 20 - 999, default 100)

Delivery traffic indication message (DTIM) rate beacon intervals (range 1 - 255, default 2)

Fragment threshold (range 256 - 2346, default 2346)

RTS threshold (range 1 - 2347, default 2347)

Short preamble ON OFF

Figure 44 - Wireless Settings - Advanced

OPTION	DEFINITION
Maximum number of connected clients	The maximum number of wireless clients that may connect to the access point. This may be a maximum of 127.
Client idle timeout	The time in seconds that a wireless client session can be idle before the router cancels the session and defines the wireless client as not connected.
Beacon interval	Interval of time in which the wireless router broadcasts a beacon which is used to synchronize the wireless network.
Delivery traffic indication message (DTIM) rate	Enter a value in milliseconds between 1 and 255 for the Delivery Traffic Indication Message (DTIM). A DTIM is a countdown informing clients of the next window for listening to broadcast and multicast messages.
Fragment threshold	This specifies the maximum size of a packet during the fragmentation of data to be transmitted. If you set this value too low, it will result in bad performance.
RTS threshold	When the packet size is smaller than the RTS threshold, the wireless router will not use the RTS/CTS mechanism to send this packet.
Short preamble	Enable or disable short preambles in use on the wireless network. Using short preambles should improve throughput, however some wireless network adapters must use long preambles.

Table 15 - Wireless Settings - Advanced Configuration Items

AP MAC filtering

The Wireless LAN AP MAC filter feature ensures the network accessibility for the wireless client devices can be controlled. When the MAC filter is enabled with an Allow policy only those wireless clients whose MAC address is listed in the MAC filter list will be able to gain network access. All other wireless client devices will be denied network access. When the MAC filter is enabled with a Block policy all wireless client devices listed whose MAC address is listed in the MAC filter list will be denied network access. All other wireless client devices will be allowed network access.

To access the AP MAC filtering page, click on the **Networking** menu at the top of the screen, click on the **Wireless settings** menu on the left then select the **AP MAC filtering** menu item.

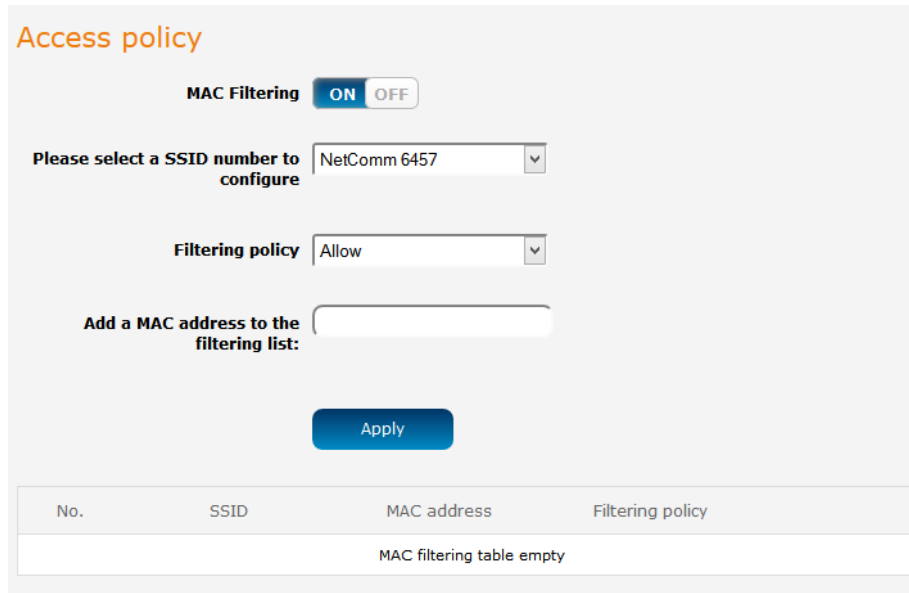

No.	SSID	MAC address	Filtering policy
MAC filtering table empty			

Figure 45 - MAC Filtering

AP station info

The Station info page shows the number of devices currently connected to your NTC-140W via Wireless. The MAC address, Host Name and IP address of these devices are displayed.

To access the AP station info page, click on the **Networking** menu at the top of the screen, click on the **Wireless settings** menu on the left then select the **AP station info** menu item.

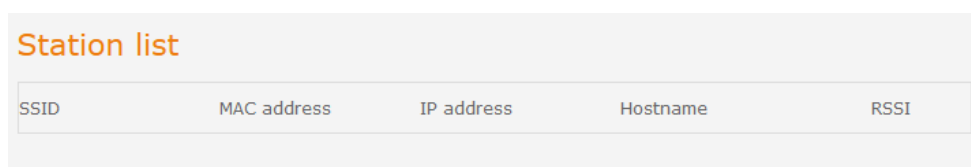

SSID	MAC address	IP address	Hostname	RSSI
------	-------------	------------	----------	------

Figure 46 - Wireless Station List

AP hotspot

The wireless hotspot feature provides internet access to WiFi clients with the option of forcing users to agree to terms of use. This feature is often used where wireless access is provided to customers in a public area and allows you to configure a speed limit on the network, limit the number of clients, configure idle and session timeouts and select to authenticate with remote RADIUS servers.

To access the AP hotspot page, click on the **Networking** menu at the top of the screen, click on the **Wireless settings** menu on the left then select the **AP hotspot** menu item.



Note: When using the Hotspot feature, we recommend that you set the Network authentication mode on the Basic page for the Hotspot's SSID to **Open** so that wireless users are not made to authenticate twice.

Wireless hotspot configuration

Hotspot functionality ON OFF

LAN interface NetComm 9522

Max client connections 31 (1-127) i

Max downlink bandwidth 50000 kbits/second

Max uplink bandwidth 50000 kbits/second

Session timeout 60 minutes

Idle timeout 60 minutes

Starting IP address 10 . 1 . 0 . 1

Netmask 255 . 255 . 255 . 0

Authentication option

Local user settings

Radius settings

Page redirect

Page redirect ON OFF

Redirect URL www.netcommwireless.com (exclude http://)

Router access permissions

Local LAN ON OFF

Router management interface ON OFF

Page customization

Upload file Choose a file

Upload

Customization files usage

Use default files

Use uploaded customization files

Landing page filename Preview

Landing page

Landing page hotspotlogin.html

Terms of use

Internal terms of use Simple text message

netcomm terms and conditions

External terms of use URL of Terms of Use page i

Save

Figure 47 - Wireless hotspot configuration

ITEM	DESCRIPTION
Hotspot functionality	Turns the wireless hotspot feature on or off.
LAN interface	Specifies the LAN interface to use for the wireless hotspot.
Max client connections	The maximum number of wireless clients permitted to connect to the wireless hotspot.
Max downlink bandwidth	The maximum downlink speed in kilobits per second.
Max uplink bandwidth	The maximum uplink speed in kilobits per second.
Session timeout	The number of minutes that a client may use the WAN connection before being forced to authenticate again.
Idle timeout	The number of minutes that a client may be idle before being forced to authenticate again.
Starting IP address	The starting IP address for the wireless hotspot network. The starting IP address is assigned to the router and subsequent addresses are assigned to clients as they connect.
Netmask	The network mask of the LAN IP range.
Authentication option	Selects whether to use the Local user settings or a remote RADIUS server to authenticate users on the wireless hotspot.
Radius settings	
Radius server 1	Primary RADIUS Server domain name e.g. radius.netcomm.com
Radius server 2	Backup RADIUS Server domain name e.g. radius.netcomm.com
Authentication port	The port used for RADIUS authentication e.g. 1205
SSID	This is usually the SSID of the hotspot and is used during the authentication process.
Shared secret	The WPA pre-shared key on the wireless network.
Re-enter shared secret	The WPA pre-shared key on the wireless network.
Page redirect	
Page redirect	Page redirect: redirects the user to a specified website after they have authenticated or agreed to terms of use. Allow internet access: allows internet access upon successful authentication or agreement with terms of use.
Redirect URL	Enter the URL (excluding http://) that you wish to redirect the user to after they have agreed to the terms of use.
Router access permissions	
Local LAN	Turning this on allows wireless hotspot clients to access clients on the local LAN and vice versa.
Router management interface	Turning this on allows wireless hotspot clients to access the router's management interface.
Page customization	
Upload file	You can package your own HTML files in a .zip, .tar.gz or .bz2 file to use as a landing page. Click the "Choose a file" button then locate the archive on your computer. Click the "Upload" button to send the archive to the router.
Customization files usage	This allows you to select whether to use the default landing page files or to use a customized set that you have uploaded.
Landing page filename	Enter the name of the file in your landing page archive that you wish to use as the initial landing page.
Terms of use	
Internal terms of use	Enter the terms and conditions as a standard text message in this field.
External terms of use	Select this option to use a terms of use page which is remote. Enter the URL of the page excluding http://

Table 16 – Wireless hotspot settings



Note: Some web browsers may experience an issue where a reconfiguration of the "External terms of use" URL causes the terms and conditions link to refresh the hotspot login page. To work around this problem, clear the web browser's cache.

Client configuration

As a wireless client, the NTC-140W is able to connect to another wireless access point to gain network or internet access. The Client configuration page provides the ability to turn on or off the wireless radio, find nearby access points and configure a connection to an access point.

The NTC-140W may run both Access Point and Client simultaneously, however, since they share the wireless channel, both client and access point must use the same channel.

To access the Client configuration page, click on the **Networking** menu at the top of the screen, click on the **Wireless settings** menu on the left then select the **Client configuration** menu item.

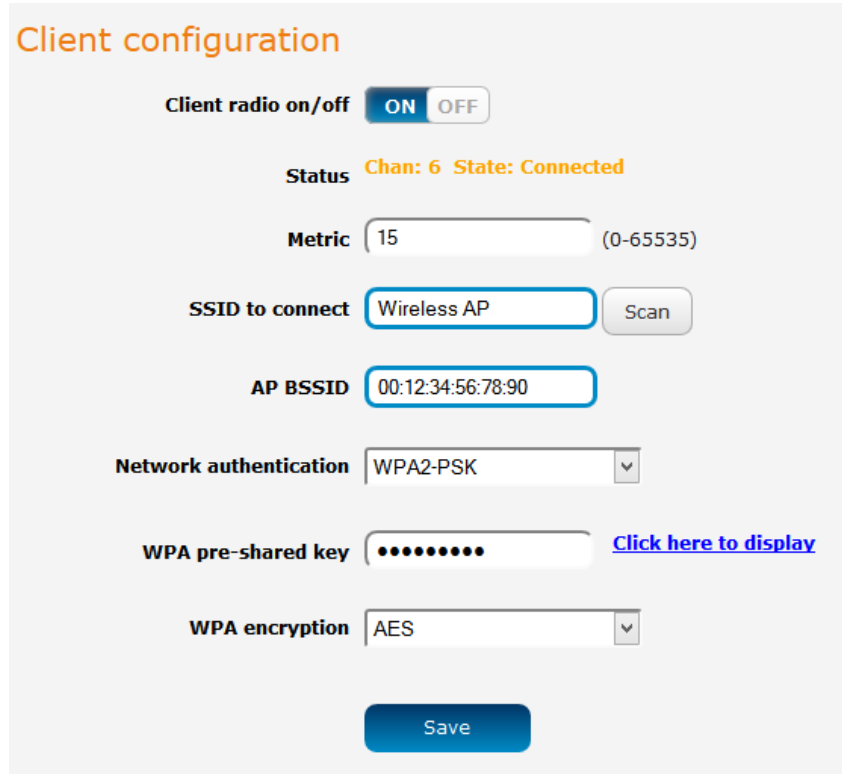

Client configuration

Client radio on/off ON OFF

Status Chan: 6 State: Connected

Metric (0-65535)

SSID to connect

AP BSSID

Network authentication ▼

WPA pre-shared key [Click here to display](#)

WPA encryption ▼

Figure 48 - Wireless settings - Client Configuration

OPTION	DEFINITION
Client radio on/off	Turns the wireless radio on or off.
Status	Displays the current channel and connection status of the wireless client.
Metric	The metric value is used by the router to prioritise routes.
SSID to connect	Enter the SSID of the network you wish to connect to or you may use the Scan button to discover nearby networks.
AP BSSID	The BSSID or MAC address of the access point to which you are connecting.
Network authentication	The type of authentication in use on the network.
WPA pre-shared key	Enter the pre-shared key required to join the wireless network.
WPA encryption	Select the type of encryption in use on the network.

Table 17 - Wireless settings – Client Configuration

Scanning for a network

To find a nearby network to connect to, click the **Scan** button. A list of discovered networks appears at the bottom of the screen. Click the corresponding **Connect** button for the network to which you would like to connect.

Access point list

No.	SSID	BSSID	Authentication	Encryption	Chan	Signal strength (dBm)	
1	XXXXXXXXXX	00:0c:43:30:52:88	WPA-PSK	TKIP	1	-49.00	<input type="button" value="Connect"/>
2	XXXXXXXXXX	00:0c:43:30:52:88	WPA2-PSK	AES	1	-49.00	<input type="button" value="Connect"/>
3	XXXXXXXXXX	00:60:64:5e:13:c2	WPA-PSK	AES	6	-75.00	<input type="button" value="Connect"/>

Figure 49 - Access point list

The network's details are copied across to the Client configuration page. If the wireless network is secured, enter the authentication details, then click the **Save** button.

Ethernet LAN/WAN

The Ethernet LAN/WAN pages provide configuration options for the two built-in Ethernet ports and any USB-to-Ethernet ports you may connect.

Ethernet group

The Ethernet group page displays the Ethernet interfaces and allows you to configure whether they operate in LAN or WAN mode.

To access the Ethernet group page, click on the **Networking** menu at the top of the screen, click on the **Ethernet LAN/WAN** menu on the left then select the **Ethernet group** menu item.

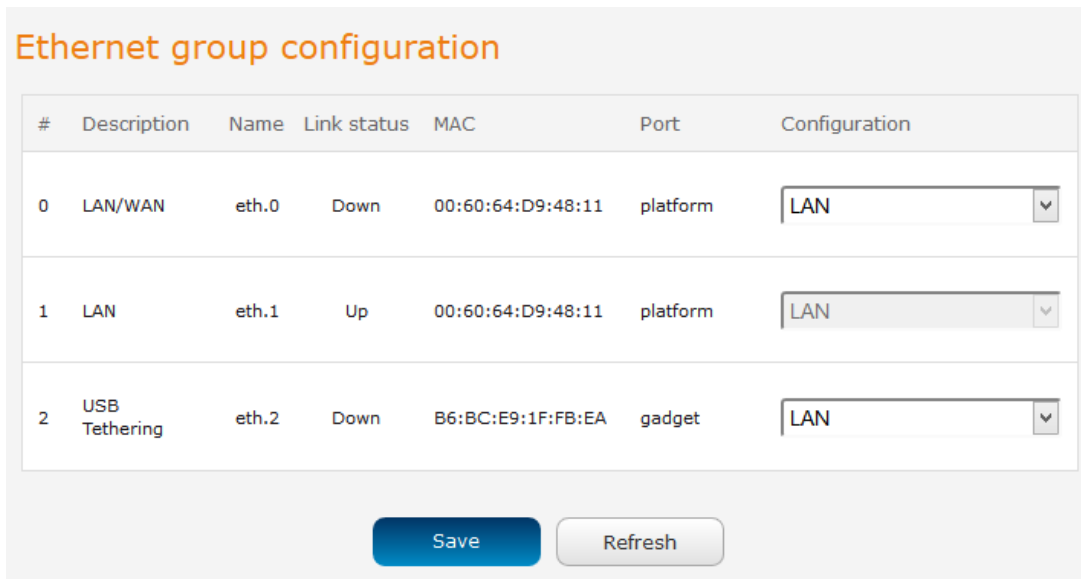

#	Description	Name	Link status	MAC	Port	Configuration
0	LAN/WAN	eth.0	Down	00:60:64:D9:48:11	platform	LAN
1	LAN	eth.1	Up	00:60:64:D9:48:11	platform	LAN
2	USB Tethering	eth.2	Down	B6:BC:E9:1F:FB:EA	gadget	LAN

Figure 50 - Ethernet group configuration

OPTION	DEFINITION
#	A number identifying the interface on the router.
Description	A description of the type of interface.
Name	The name used to identify the interface on the router.
Link status	Displays whether the interface is inserted
MAC	The MAC address of the interface.
Port	The type of port.
Configuration	Select whether the port operates as a LAN or WAN port.

Table 18 - Ethernet group configuration items

Ethernet WAN

The Ethernet WAN page allows you to configure the connection type and metric of the available WAN connections. To access the Ethernet WAN page, click on the **Networking** menu at the top of the screen, click on the **Ethernet LAN/WAN** menu on the left then select the **Ethernet WAN** menu item.

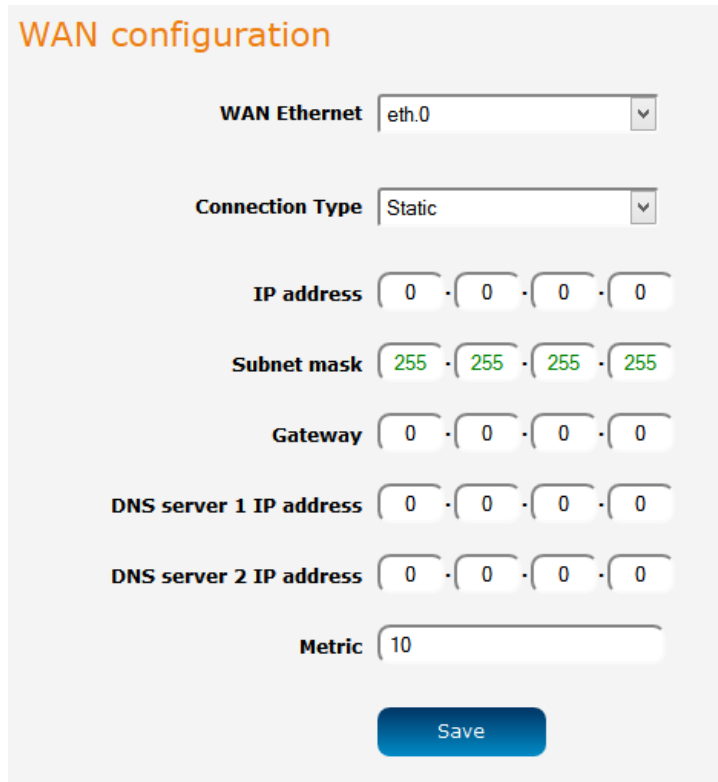

WAN configuration

WAN Ethernet: eth.0

Connection Type: Static

IP address: 0 . 0 . 0 . 0

Subnet mask: 255 . 255 . 255 . 255

Gateway: 0 . 0 . 0 . 0

DNS server 1 IP address: 0 . 0 . 0 . 0

DNS server 2 IP address: 0 . 0 . 0 . 0

Metric: 10

Save

Figure 51 - Ethernet WAN configuration

OPTION	DEFINITION
WAN Ethernet	Use this field to select the WAN interface to configure.
Connection Type	Selects whether the WAN interface has static IP settings or DHCP.
IP address	The IP address to assign to the selected WAN interface.
Subnet mask	The Subnet mask of the IP address above.
Gateway	The gateway to assign this WAN interface.
DNS server 1 IP address	The first DNS server for the WAN interface.
DNS server 2 IP address	The second DNS server for the WAN interface.
Metric	The metric value is used to define the priority of the interface. Lower metric values indicate higher priority.

Table 19 - Ethernet WAN configuration options

PPPoE

If desired, you can have a client device connected to the Ethernet port initiate the mobile broadband connection using a PPPoE session. This is particularly useful in situations where you wish to provide Wireless WAN data access to an existing router which you want to have full public WAN IP access and have control over routing functionality. The PPPoE connection is established over the highest priority interface.

To configure PPPoE:

1. Select the **Networking** menu item from the top menu bar, then select the **PPPoE** menu on the left side of the screen. The PPPoE configuration screen is displayed.

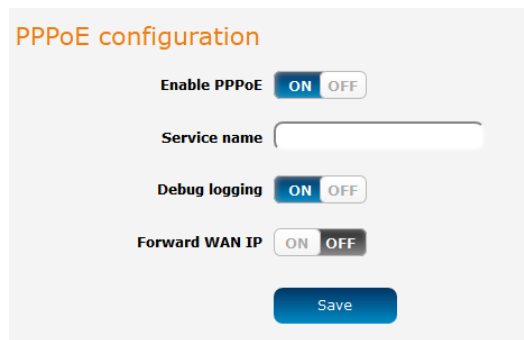

Figure 52 - PPPoE configuration

2. Click the **Enable PPPoE** toggle key so that it is **ON**.
3. (Optional) In the **Service name** field, enter a name to use for the connection. This name is displayed on the Status page to identify the PPPoE connection. Any name you enter here must also be entered in the PPPoE connection profile in order for it to work.
4. If you require additional logging to be made available, click the **Debug logging** toggle key so that it is in the **ON** position. This displays PPPoE negotiation details in the System log.
5. The **Forward WAN IP** option determines whether the router passes the WAN IP address on to the PPPoE client. When this option is set to **ON** the first PPPoE client to connect will receive the WAN IP address and no further clients will be able to make a connection. In this mode, the router transparently bridges the connection and many of the router's features are disabled. When this option is set to **OFF**, the router retains the WAN IP address and performs Network Address Translation (NAT) for connected clients. In this mode, you are able to connect multiple PPPoE clients and all of the router's features are available.
6. Click the **Save** button to confirm the settings.
7. Click the **Status** menu item from the top menu bar. When Forward WAN IP is enabled, the status page shows a **Transparent bridge mode** section and displays the WAN IP.

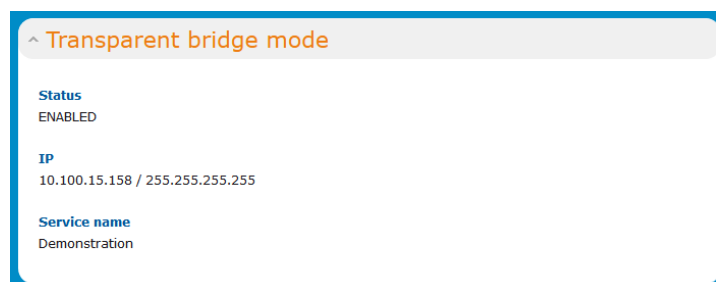

Figure 53 - Transparent bridge mode status

8. Configure the properties of the interface that the PPPoE connection will use (determined by WAN priority) in order to provide authentication credentials. Each interface uses the authentication credentials configured on the router for that particular interface, not those entered in the PPPoE client. For example, when using WWAN as the PPPoE interface, enter the username and password on the Data connection profile settings before connecting. See the [Manually configuring a connection profile](#) section for more detail.
9. Use your downstream device to initiate a network connection using a PPPoE client.

WAN failover

The WAN failover page displays a summary of the configured WAN interfaces and their priorities (Metric). Lower metric values determine higher priority. The priority of the interfaces can be adjusted using the up and down arrows in the Priority column. When the interface with the highest priority goes down, the router fails over to the next highest priority interface. The method used to determine whether an interface is “up” or “down” is defined by the Monitor setting. By default, an interface is monitored by its link status.

To access the WAN failover page, click on the **Networking** menu at the top of the screen then click on the **WAN** failover menu item on the left.

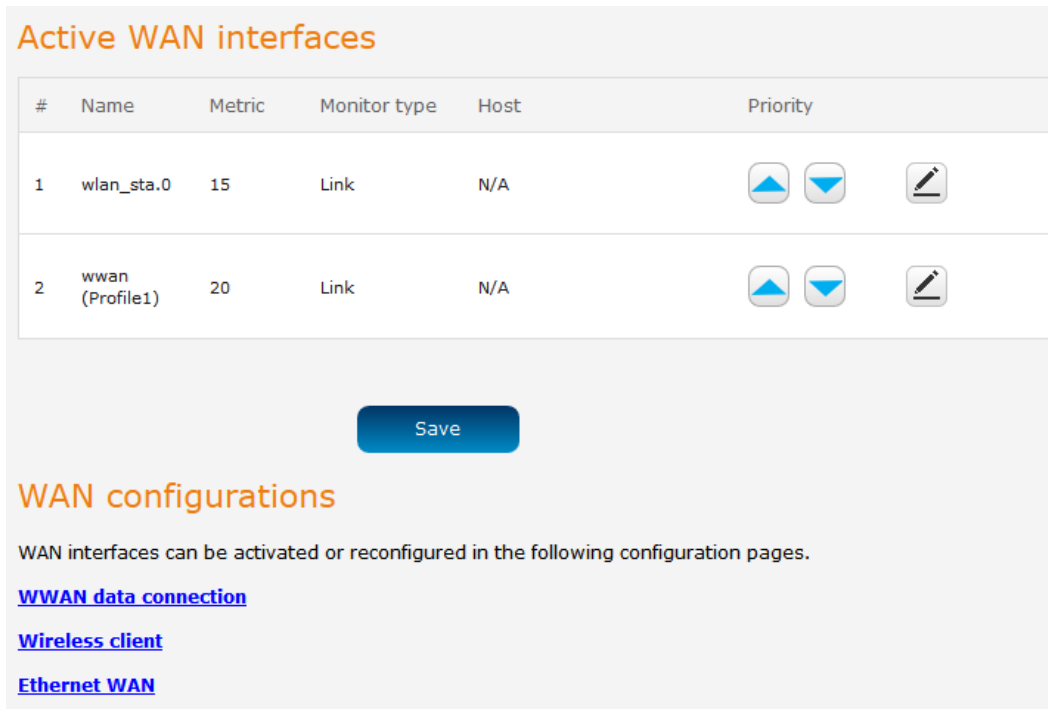

Active WAN interfaces

#	Name	Metric	Monitor type	Host	Priority
1	wlan_sta.0	15	Link	N/A	<input type="button" value="▲"/> <input type="button" value="▼"/> <input type="button" value="✎"/>
2	wwan (Profile1)	20	Link	N/A	<input type="button" value="▲"/> <input type="button" value="▼"/> <input type="button" value="✎"/>

WAN configurations

WAN interfaces can be activated or reconfigured in the following configuration pages.

- [WWAN data connection](#)
- [Wireless client](#)
- [Ethernet WAN](#)

Figure 54 - WAN summary

To edit an interface, select the edit icon for the interface you wish to edit. The Failover configuration page is displayed. When Monitoring method is set to **Hardware link** the failover is controlled by the physical detection of the link.

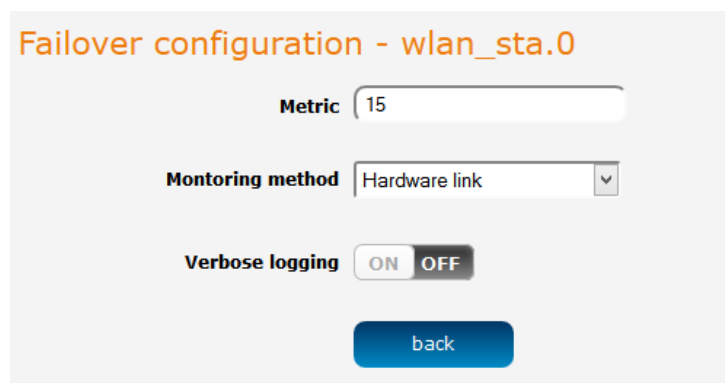

Failover configuration - wlan_sta.0

Metric

Monitoring method

Verbose logging ON OFF

Figure 55 – Failover configuration – hardware link

OPTION	DESCRIPTION
Priority	The priority (metric) is a numeric value which determines which interface has priority. Lower priority values mean higher priority.
Monitoring method	Specifies the means used to determine whether the link is up or down.
Verbose logging	When enabled, this logs verbose comments in the system log related to the failover monitoring.

Table 20 - Failover configuration - Hardware link monitoring

When Monitoring method is set to **Ping**, the router sends periodic ping requests to the specified addresses to verify the connection is working. This works in a similar manner to the Watchdogs feature but with different ranges on the timers. Please refer to the [Watchdogs](#) section of this user guide for a more detailed description of this function.

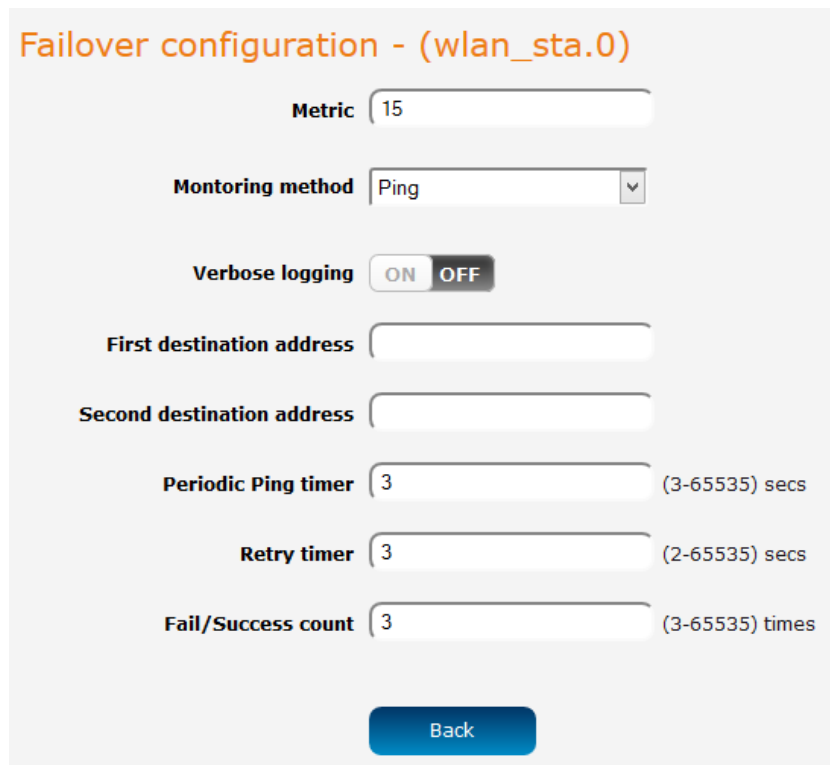

Figure 56 - Failover configuration - ping

OPTION	DESCRIPTION
Priority	The priority (metric) is a numeric value which determines which interface has priority. Lower priority values mean higher priority.
Monitoring method	Specifies the means used to determine whether the link is up or down.
Verbose logging	When enabled, this logs verbose comments in the system log related to the failover monitoring.
First destination address	The first address the router that the router should ping in order to confirm the connection is up. This may be an IP address or a domain name.
Second destination address	The second address the router that the router should ping in order to confirm the connection is up. This may be an IP address or a domain name.
Periodic Ping timer	The time in seconds between ping attempts.
Retry timer	The time in seconds between attempts when a ping failure occurs.
Fail/Success count	The number of failed pings that must occur before the monitor moves to the second destination address or fails the connection over to the next interface. When running on a lower priority interface, this also indicates the number of pings that must succeed before the router fails back to the higher priority interface.

Table 21 - Failover configuration - Ping monitoring

Routing



Static

Static routing is the alternative to dynamic routing used in more complex network scenarios and is used to facilitate communication between devices on different networks. Static routing involves configuring the routers in your network with all the information necessary to allow the packets to be forwarded to the correct destination. If you change the IP address of one of the devices in the static route, the route will be broken.

To access the Static routing page, click on the **Networking** menu at the top of the screen, click on the **Routing** menu on the left, then click on the **Static** menu item.

Static routing list

+ Add

Route name	Destination network address	Subnet mask	Gateway IP address	Network interface	Metric		
MyRoute	192.168.20.0	255.255.255.0	192.168.1.101	Auto	0		

Active routing list

Destination	Gateway	Netmask	Flags	Metric	Ref	Use	Interface
0.0.0.0	120.157.26.49	0.0.0.0	UG	20	0	0	rmnet1
120.157.26.48	0.0.0.0	255.255.255.240	U	0	0	0	rmnet1
192.168.1.0	0.0.0.0	255.255.255.0	U	0	0	0	br0
192.168.20.0	192.168.1.101	255.255.255.0	UG	0	0	0	br0

Figure 57 - Static routing list

Some routes are added by default by the router on initialization such as the Ethernet subnet route for routing to a device on the Ethernet subnet.

Adding Static Routes

To add a new route to the static routing list, click the **+Add** button. The Static routes page appears.

1. In the **Route name** field, type a name for the route so that it can be identified in the static routing list.
2. From the **Network interface** drop down list, select the interface for which you would like to create a static route.
3. In the **Destination IP address** field, enter the IP address of the destination of the route.
4. In the **IP subnet mask** field, enter the subnet mask of the route.
5. In the **Gateway IP address** field, enter the IP address of the gateway that will facilitate the route.
6. In the **Metric** field enter the metric for the route. The metric value is used by the router to prioritise routes. The lower the value, the higher the priority. To give the route the highest priority, set it to 0.
7. Click the **Save** button to save your settings.

Static routes

Route name

Network interface

Destination network address · · ·

Destination subnet mask · · ·

Gateway IP address · · ·

Metric (0-65535)

Figure 58 - Adding a static route

Active routing list

Static routes are displayed in the Active routing list.

Active routing list

Destination	Gateway	Netmask	Flags	Metric	Ref	Use	Interface
0.0.0.0	120.157.26.49	0.0.0.0	UG	20	0	0	rmnet1
120.157.26.48	0.0.0.0	255.255.255.240	U	0	0	0	rmnet1
192.168.1.0	0.0.0.0	255.255.255.0	U	0	0	0	br0
192.168.20.0	192.168.1.101	255.255.255.0	UG	0	0	0	br0

Figure 59 - Active routing list

Deleting static routes

From the static routing list, click the  icon to the right of the entry you wish to delete.

Static routing list



Route name	Destination network address	Subnet mask	Gateway IP address	Network interface	Metric	
MyRoute	192.168.20.0	255.255.255.0	192.168.1.101	Auto	0	 

Figure 60 - Deleting a static route

RIP

RIP (Routing Information Protocol) is used for advertising routes to other routers. Thus all the routes in the router's routing table will be advertised to other nearby routers. For example, the route for the router's Ethernet subnet could be advertised to a router on the PPP interface side so that a router on this network will know how to route to a device on the router's Ethernet subnet. Static routes must be added manually according to your requirements. See [Adding Static Routes](#).

To access the RIP configuration page, click on the **Networking** menu at the top of the screen, click on the **Routing** failover menu on the left, then click on the **RIP** menu item.



Note: Some routers will ignore RIP.

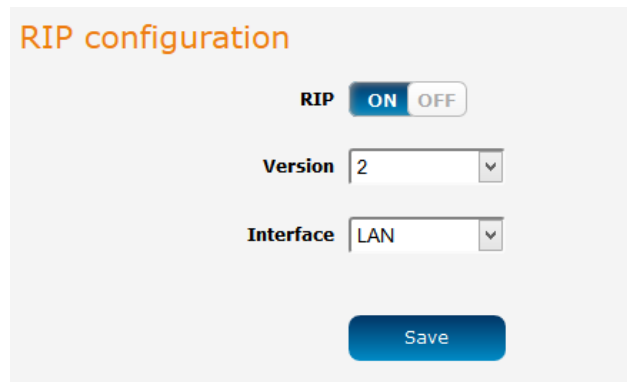

Figure 61 - RIP configuration

To enable Routing Information Protocol (RIP)

1. Click the **RIP** toggle key to switch it to the **ON** position.
2. Using the **Version** drop down list, select the version of RIP that you would like to use.
3. Select the interface for which you want RIP to apply. You can choose the **LAN** interface, the **WWAN** interface or **BOTH**.
4. Click the **Save** button to confirm your settings.

Redundancy (VRRP) configuration

Virtual Router Redundancy Protocol (VRRP) is a non-proprietary redundancy protocol designed to increase the availability of the default gateway servicing hosts on the same subnet. This increased reliability is achieved by advertising a “virtual router” (an abstract representation of master and backup routers acting as a group) as a default gateway to the host(s) instead of one physical router. Two or more physical routers are then configured to stand for the virtual router, with only one doing the actual routing at any given time. If the current physical router that is routing the data on behalf of the virtual router fails, an arrangement is made for another physical router to automatically replace it. The physical router that is currently forwarding data on behalf of the virtual router is called the master router. Master routers have a priority of 255 and backup router(s) can have a priority between 1 and 254.

A virtual router must use 00-00-5E-00-01-XX as its (MAC) address. The last byte of the address (XX) is the Virtual Router Identifier (VRID), which is different for each virtual router in the network. This address is used by only one physical router at a time, and is the only way that other physical routers can identify the master router within a virtual router.

To access the Redundancy (VRRP) page, click on the **Networking** menu at the top of the screen, click on the **Routing** failover menu on the left, then click on the **Redundancy (VRRP)** menu item.

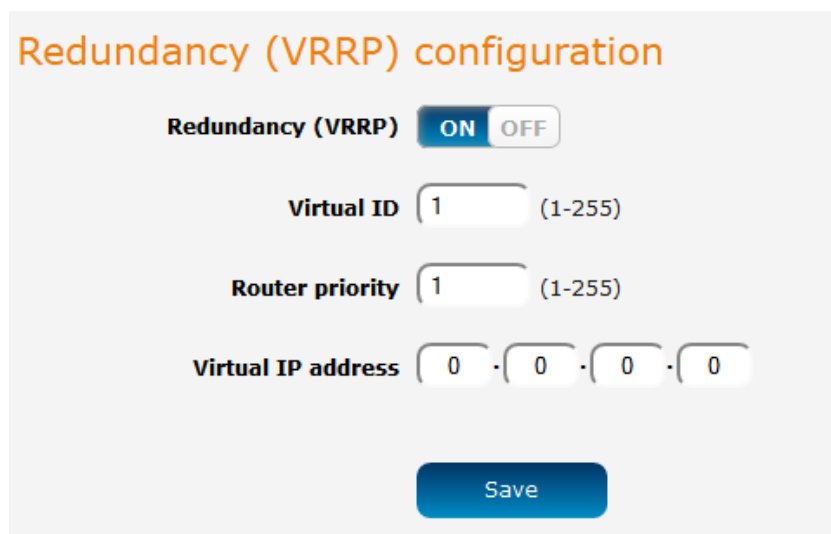

Figure 62 - VRRP configuration

To configure VRRP, configure multiple devices as follows and connect them all via an Ethernet network switch to downstream devices.

1. Click the **Redundancy (VRRP)** toggle key to activate VRRP.
2. In the **Virtual ID** field, enter an ID between 1 and 255. This is the VRRP ID which is different for each virtual router on the network.
3. In the **Router priority** field, enter a value for the priority – a higher value is a higher priority.
4. The **Virtual IP address** field is used to specify the VRRP IP address – this is the virtual IP address that both virtual routers share.
5. Click the **Save** button to save the new settings.



Note: Configuring VRRP changes the MAC address of the Ethernet port and therefore if you want to resume with the web configuration you must use the new IP address (VRRP IP) or on a command prompt type: `arp -d <ip address>` (i.e. `arp -d 192.168.1.1`) to clear the arp cache.(old MAC address).

Port forwarding

The Port forwarding list is used to configure the Network Address Translation (NAT) rules currently in effect on the router. To access the Port forwarding page, click on the **Networking** menu at the top of the screen, click on the **Routing** failover menu on the left, then click on the **Port forwarding** menu item.

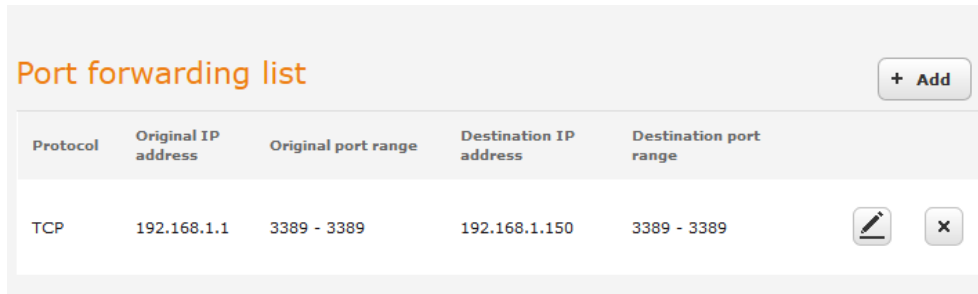

Protocol	Original IP address	Original port range	Destination IP address	Destination port range
TCP	192.168.1.1	3389 - 3389	192.168.1.150	3389 - 3389

Figure 63 – Port forwarding list

The purpose of the port forwarding feature is to allow mapping of inbound requests to a specific port on the WAN IP address to a device connected on the Ethernet interface.

Adding a port forwarding rule

To create a new port forwarding rule:

1. Click the **+Add** button. The port forwarding settings screen is displayed.
2. Use the **Protocol** drop down list to select the type of protocol you want to use for the rule. The protocols selections available are **TCP**, **UDP** and **All**.
3. In the **Source IP Address** field, enter a “friendly” address that is allowed to access the router or a wildcard IP address (0.0.0.0) that allows all IP addresses to access the router.
4. The **Source Port Range (From)** and **(To)** fields are used to specify the port(s) on the source side that are to be forwarded. This allows you to send a range of consecutive port numbers by entering the first in the range in the **(From)** field and the last in the range in the **(To)** field. To forward a single port, enter the port in the **(From)** field and repeat it in the **(To)** field.
5. In the **Destination network address** field, enter the IP address of the client to which the traffic should be forwarded.
6. The **Destination Port Range (From)** and **(To)** fields are used to specify the port(s) on the destination side that are to be forwarded. If the Source port range specifies a single port then the destination port may be configured to any port. If the Source port range specifies a range of port numbers then the Destination port range must be the same as the Source port range.
7. Click the **Save** button to confirm your settings.

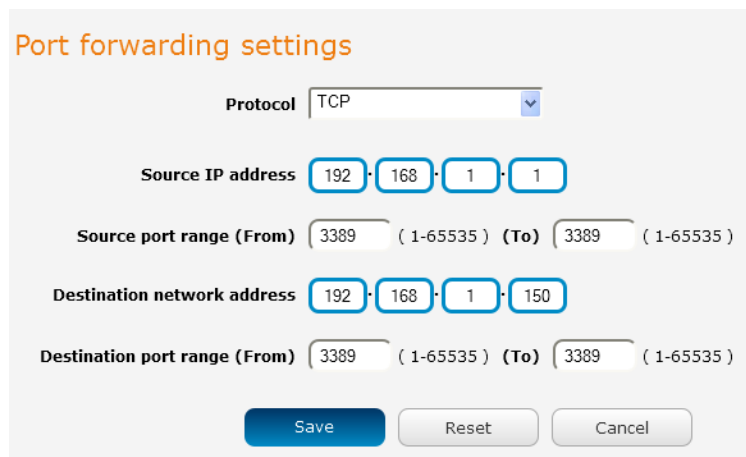

Port forwarding settings

Protocol:

Source IP address: · · ·

Source port range (From): (1-65535) (To): (1-65535)

Destination network address: · · ·

Destination port range (From): (1-65535) (To): (1-65535)

Figure 64 - Port forwarding settings

To delete a port forwarding rule, click the  button on the Port forwarding list for the corresponding rule that you would like to delete.

DMZ

The Demilitarized Zone (DMZ) allows you to configure all incoming traffic on all protocols to be forwarded to a selected device behind the router. This feature can be used to avoid complex port forwarding rules, but it exposes the device to untrusted networks as there is no filtering of what traffic is allowed and what is denied. The DMZ configuration page is used to specify the IP Address of the device to use as the DMZ host.

To access the DMZ page, click on the **Networking** menu at the top of the screen, click on the **Routing** failover menu on the left, then click on the **DMZ** menu item.



DMZ configuration

DMZ ON OFF

DMZ IP address 192 . 168 . 1 . 101

Save

Figure 65 - DMZ configuration

1. Click the DMZ toggle key to turn the DMZ function **ON**.
2. Enter the IP Address of the device to be the DMZ host into the **DMZ IP Address** field.
3. Click the **Save** button to save your settings.

Router firewall

The Router firewall page is used to enable or disable the in-built firewall on the router. When enabled, the firewall performs stateful packet inspection on inbound traffic from the wireless WAN and blocks all unknown services, that is, all services not listed on the Services configuration page of the router.

With respect to the other Routing options on the Networking page, the firewall takes a low priority. The priority of the firewall can be described as:

DMZ > MAC/IP/Port filtering rules > MAC/IP/Port filtering default rule > Router firewall rules

In other words, the firewall is of the lowest priority when compared to other manual routing configurations. Therefore, a MAC/IP/Port filtering rule takes priority in the event that there is a conflict of rules. When DMZ is enabled, MAC/IP/Port filtering rules and the router firewall are ignored but the router will still honour the configuration of the Remote router access control settings listed under Administration Settings.

To access the DMZ page, click on the **Networking** menu at the top of the screen, click on the **Routing** failover menu on the left, then click on the **Router firewall** menu item.

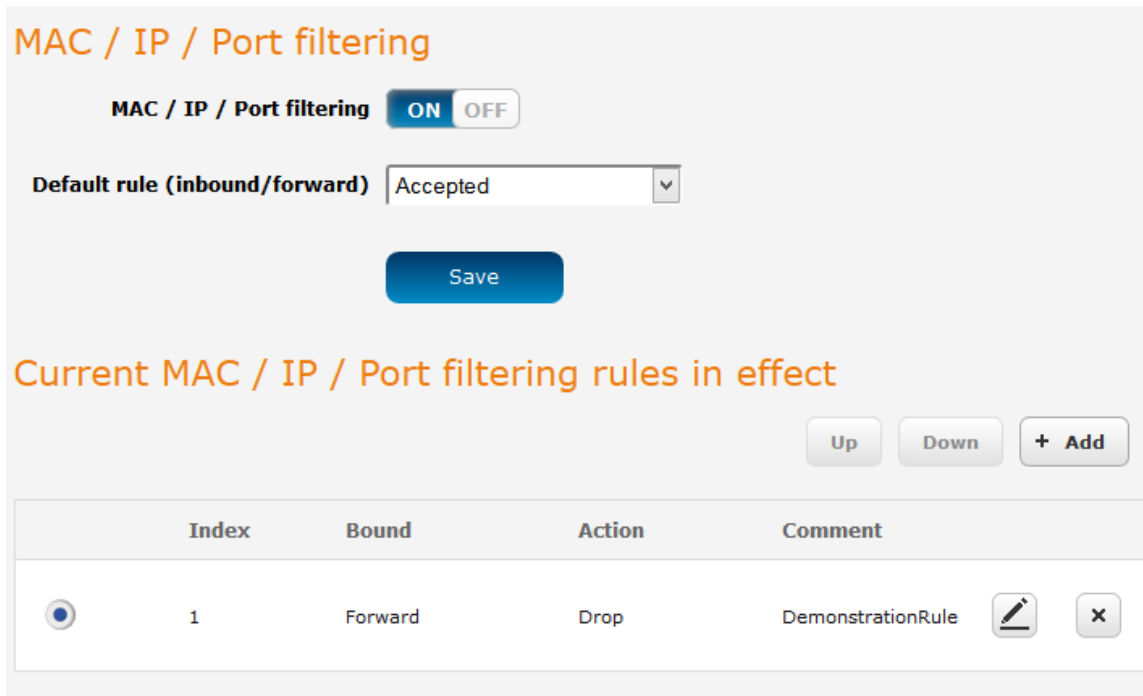

Figure 66 - Router firewall toggle key

MAC / IP / Port filtering

The MAC/IP/Port filter feature allows you apply a policy to the traffic that passes through the router, both inbound and outbound, so that network access can be controlled. When the filter is enabled with a default rule of “Accepted”, all connections will be allowed except those listed in the “Current MAC / IP / Port filtering rules in effect” list. Conversely, when the default rule is set to “Dropped”, all connections are denied except for those listed in the filtering rules list.

To access the MAC / IP / Port filtering page, click on the **Networking** menu at the top of the screen, click on the **Routing** failover menu on the left, then click on the **MAC / IP / Port filtering** menu item.



MAC / IP / Port filtering ON OFF

Default rule (inbound/forward) Accepted

Save

Current MAC / IP / Port filtering rules in effect

Up Down + Add

Index	Bound	Action	Comment
1	Forward	Drop	DemonstrationRule ✎ ✕

Figure 67 - MAC / IP / Port filtering



Note: When enabling MAC / IP / Port filtering and setting the default rule to “Dropped”, you should ensure that you have first added a filtering rule which allows at least one known MAC/IP to access the router, otherwise you will not be able to access the user interface of the router without resetting the router to factory default settings.

Creating a MAC / IP / Port filtering rule

To create a filtering rule:

1. Click the **MAC / IP / Port filtering** toggle key to switch it to the **ON** position.
2. Using the **Default rule (inbound/forward)** drop down list, select the default action for the router to take when traffic reaches it. By default, this is configured to **Accepted**. If you change this to **Dropped**, you should first configure a filter rule that allows at least one device access to the router, otherwise you will effectively be locked out of the router.
3. Click the **Save** button to confirm the default rule.
4. In the Current MAC / IP / Port filtering rules in system section, click the **+Add** button.



Current MAC / IP / Port filtering rules in effect

Up Down + Add

Index	Bound	Action	Comment
MAC / IP / Port filtering rule is empty			

Save **Reset**

Figure 68 - Current MAC / IP / Port filtering rules in effect

5. Enter the details of the rule in the section that is displayed and click the **Save** button.

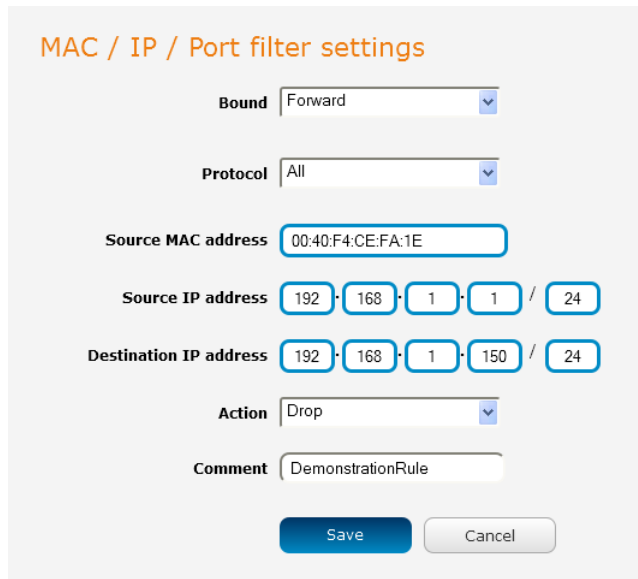

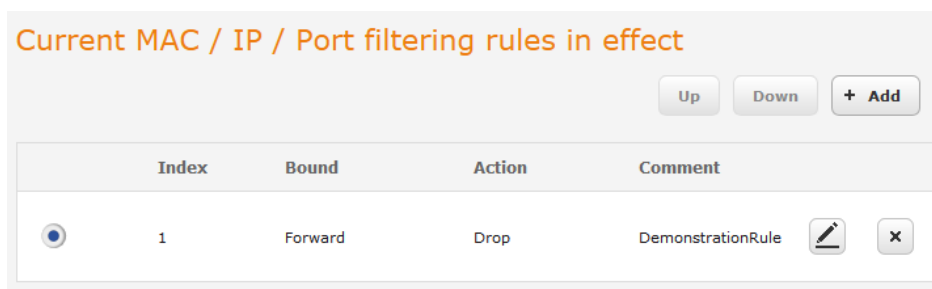

Figure 69 - MAC / IP / Port filtering settings

OPTION	DESCRIPTION
Bound	Use the drop down list to select the direction of the traffic for which you want to apply to the rule. Inbound refers to all traffic that is entering the router including data entering from the WAN and the LAN. Outbound refers to all traffic exiting the router including traffic leaving in the direction of the WAN and traffic leaving in the direction of the LAN. Forward specifies traffic that enters on the LAN or WAN side and is forwarded to the opposite end.
Protocol	Use the drop down list to select the protocol for the rule. You can have the rule apply to All protocols, TCP , UDP , UDP/TCP or ICMP .
Source MAC Address	Enter the MAC address in six groups of two hexadecimal digits separated by colons (:). e.g. 00:40:F4:CE:FA:1E
Source IP Address	Enter the IPv4 address that the traffic originates from and the subnet mask using CIDR notation.
Destination IP Address	Enter the IPv4 address that the traffic is destined for and the subnet mask using CIDR notation.
Action	Select the action to take for traffic which meets the above criteria. You can choose to Accept or Drop packets. When the default rule is set to Accept , you cannot create a rule with an Accept action since the rule is redundant. Likewise, if the default rule is set to Dropped you cannot create a rule with a Drop action.
Comment	[Optional] Use this field to enter a comment as a meaningful description of the rule.

Table 22 - Current MAC / IP / Port filtering rules in effect

6. The new rule is displayed in the filtering rules list. You can edit the rule by clicking the  **Edit** button or delete the rule by clicking the  button.





Current MAC / IP / Port filtering rules in effect				
Index	Bound	Action	Comment	
1	Forward	Drop	DemonstrationRule	 

Figure 70 - Completed filtering rule

VPN

A Virtual Private Network (VPN) is a tunnel providing a private link between two networks or devices over a public network. Data to be sent via a VPN needs to be encapsulated and as such is generally not visible to the public network.

The advantages of a VPN connection include:

-  Data Protection
-  Access Control
-  Data Origin Authentication
-  Data Integrity

Each VPN connection has different configuration requirements. The following pages detail the configuration options available for the different VPN connection types.



Note: The following descriptions are an overview of the various VPN options available. More detailed instructions are available in separate whitepapers on the NetComm Wireless website.

IPSec

IPSec operates on Layer 3 of the OSI model and as such can protect higher layered protocols. IPSec is used for both site to site VPN and Remote Access VPN. The NTC-140W Series router supports IPSec end points and can be configured with Site to Site VPN tunnels with third party VPN routers.

Configuring an IPSec VPN

From the menu at the top of the screen, click **Networking** and under the VPN section, click **IPSec**. A list of configured IPSec VPN connections is displayed.

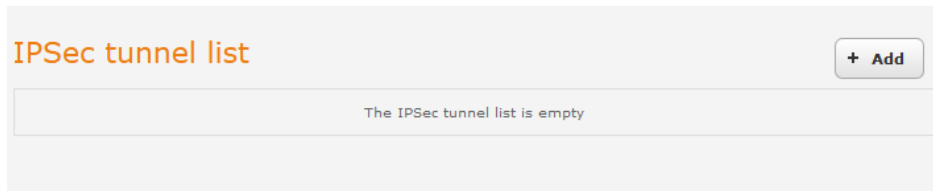

Figure 71 - IPSec VPN List

Click the **+Add** button to begin configuring an IPSec VPN connection.

IPSec profile edit

IPSec profile ON OFF

Profile name

Remote IPSec address

Remote LAN address · · ·

Remote LAN subnet mask · · ·

Local LAN address · · ·

Local LAN subnet mask · · ·

Encapsulation type ▾

IKE mode ▾

PFS ▾

IKE encryption ▾

IKE hash ▾

IPSec encryption ▾

IPSec hash ▾

DH group ▾

DPD action ▾

DPD keep alive time secs

DPD timeout secs

IKE re-key time (0-78400, 0=Unlimited) secs

SA life time (0-78400, 0=Unlimited) secs

Key mode ▾

Pre-shared key

Remote ID (xy.sample.com or blank)

Local ID (xy.sample.com or blank)

Figure 72 – IPSec profile edit

The following table describes each of the fields of the IPSec VPN Connection Settings page.

ITEM	DEFINITION
IPSec profile	Enables or disables the VPN profile.
Profile name	A name used to identify the VPN connection profile.
Remote IPSec address	The IP address or domain name of the IPSec server.
Remote LAN address	Enter the IP address of the remote network for use on the VPN connection.
Remote LAN subnet mask	Enter the subnet mask in use on the remote network.
Local LAN address	Enter the IP address of the local network for use on the VPN connection.
Local LAN subnet mask	Enter the subnet mask in use on the local network.
Encapsulation type	Select the encapsulation protocol to use with the VPN connection. You can choose ESP , AH or Any .
IKE mode	Select the IKE mode to use with the VPN connection. You can choose Main , Aggressive or Any .
PFS	Choose whether Perfect Forward Secrecy is ON or OFF for the VPN connection.
IKE encryption	Select the cipher type to use for the Internet Key Exchange.
IKE hash	Select the IKE Hash type to use for the VPN connection. The hash is used for authentication of packets for the key exchange.
IPSec encryption	Select the IPSec encryption type to use with the VPN connection.
IPSec hash	Select the IPSec hash type to use for the VPN connection. The hash is used for authentication of packets for the VPN connection.
DH group	Select the desired Diffie-Hellman group to use. Higher groups are more secure but also require longer to generate a key.
DPD action	Select the desired Dead Peer Detection action. This is the action to take when a dead Internet Key Exchange Peer is detected.
DPD keep alive time	Enter the time in seconds for the interval between Dead Peer Detection keep alive messages.
DPD timeout	Enter the time in seconds of no response from a peer before Dead Peer Detection times out.
IKE re-key time	Enter the time in seconds between changes of the encryption key. To disable changing the key, set this to 0.
SA life time	Enter the time in seconds for the security association lifetime.
Key mode	Select the type of key mode in use for the VPN connection. You can select from: <ul style="list-style-type: none"> • Pre Shared Key • RSA keys • Certificates
Pre-shared key	The pre-shared key is the key that peers used to authenticate each other for Internet Key Exchange. Double quotation marks (") are not supported in this field.
Remote ID	Specifies the domain name of the remote network.
Local ID	Specifies the domain name of the local network.
Update Time	Displays the last time the key was updated.
Local RSA Key Upload	Select the RSA key file for the local router here by clicking the Browse button.
Remote RSA Key Upload	Select the RSA key file for the remote router here by clicking the Browse button.
Private key Passphrase	The Private key passphrase of the router is the passphrase used when generating the router's private key using OpenSSL CA.
Key / Certificate	Select the type of key or certificate to use for authentication. You can select Local private key , Local public certificate , Remote public certificate , CA certificate , CRL certificate .
IPSec Certificate Upload	Select the IPSec certificate to upload by clicking the Browse button.

Table 23 - IPSec Configuration Items

OpenVPN

OpenVPN is an open source virtual private network (VPN) program for creating point-to-point or server-to-multi-client encrypted tunnels between host computers. It can traverse network address translation (NAT) and firewalls and allows authentication by certificate, pre-shared key or username and password. OpenVPN works well through proxy servers and can run over TCP and UDP transports. Support for OpenVPN is available on several operating systems, including Windows, Linux, Mac OS, Solaris, OpenBSD, FreeBSD, NetBSD and QNX.

Configuring an Open VPN server

From the menu at the top of the screen, click **Networking** and from the VPN section on the left, click **OpenVPN**. A list of configured OpenVPN VPN connections is displayed.

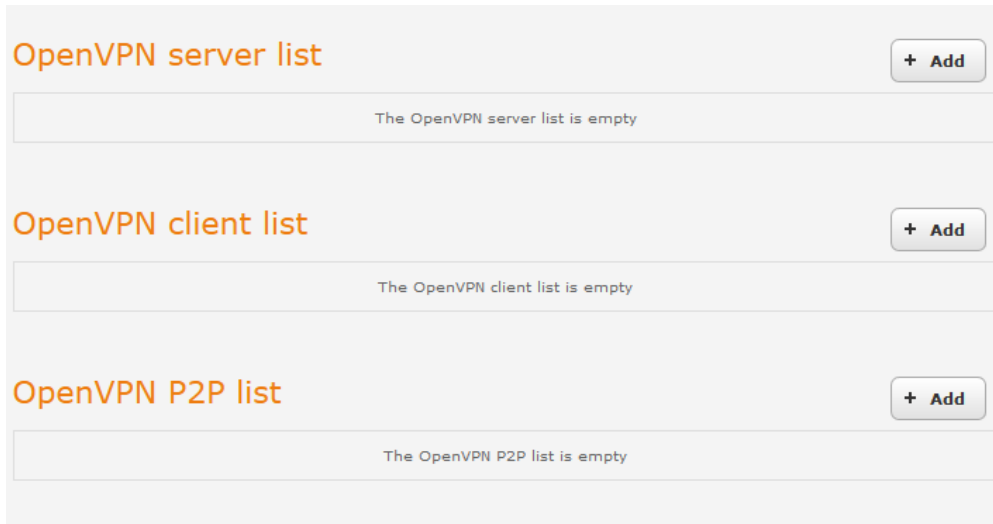
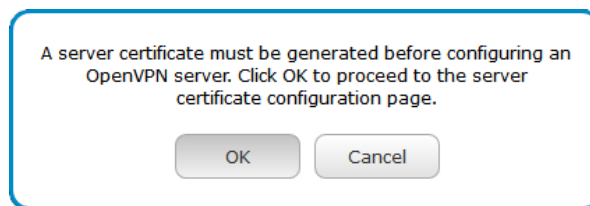

Figure 73 - OpenVPN VPN List

Click the **+Add** button for the type of OpenVPN server/client you would like to configure.

OpenVPN Server

When you select the +Add button to add an OpenVPN server, the router checks whether there are existing server certificates. If no server certificate is found, you are informed that you must generate a certificate before configuring the OpenVPN server.



Click on the **OK** button to be taken to the **Server certificate** page. For more information on generating server certificates, refer to the Server certificate section of this guide. When you have created the certificate, return to the OpenVPN server configuration page and continue with the steps below.

To configure an OpenVPN Server:

1. Click the **OpenVPN profile** toggle key to switch it to the **ON** position.
2. Type a name for the OpenVPN server profile you are creating.
3. In the **Type** drop down list, select the OpenVPN connection type (TUN/TAP). Default is **TUN**.
4. Use the **Server** port field to select a port number and then use the drop down list to select a packet type to use for your OpenVPN Server. The default OpenVPN port is 1194 and default packet type is UDP.
5. In the **VPN network address** and **VPN network subnet mask** fields, enter the IP address and network subnet mask to assign to your VPN. This is ideally an internal IP address which differs from your existing address scheme.

6. The **Server certificates** section displays the details of the certificate. If you wish to change the certificate, click the **Change** button.
7. HMAC or Hash-based Message Authentication Code is a means of calculating a message authentication code through the use of a cryptographic hash function and a cryptographic key. If you wish to use the HMAC signature as an additional key and level of security, under the SSL/TLS handshake section, click the **Use HMAC Signature** toggle key so that it is in the **ON** position, then click the **Generate** button so that the router can randomly generate the key. The Server key timestamp field is updated with the time that the key was generated. Click the **Download** button to download the key file so that it can be uploaded on the client.
8. Select an Authentication type. Authentication may be done using a **Certificate** or **Username / Password**.

Certificate Authentication

In the Certificate Management section, enter the required details to create a client certificate. All fields are required. When you have finished entering the details, click the **Generate** button.

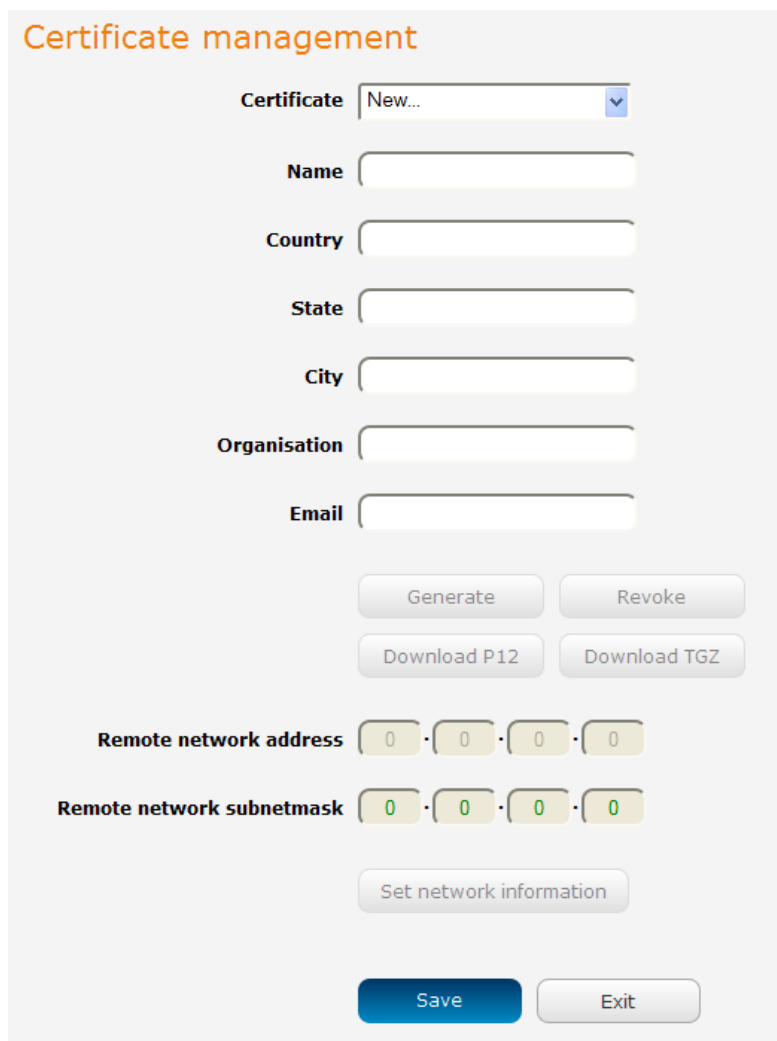

Figure 74 - OpenVPN server configuration – Certificate management

When it is done, you can click the **Download P12** button or the **Download TGZ** button to save the certificate file depending on which format you would like. If for some reason the integrity of your network has been compromised, you can return to this screen and use the Certificate drop down list to select the certificate and then press the **Revoke** button to disable it.

Optional: To inform the OpenVPN server of the network address scheme of the currently selected certificate, enter the network address and network subnet mask in the respective fields and click the **Set network information** button. If you do not enter the remote subnet here, any packet requests from the server to the client will not be received by the client network because it is not aware of the remote client's subnet.

OpenVPN server edit

OpenVPN profile ON OFF

Profile name

Type

Server port

VPN network address

VPN network subnet mask

Server certificates

Not before Mar 13 04:21:03 2015 GMT

Not after Mar 10 04:21:03 2025 GMT

Country AU

State NSW

City Sydney

Organisation NetComm Wireless

Email techsupport@netcommwireless.com

SSL/TLS handshake

Use HMAC Signature ON OFF

Server key timestamp 2015-03-13 16:49:48

Authentication type

Certificate Username / Password

Certificate management

Certificate

Name

Country

State

City

Organisation

Email

Remote network address

Remote network subnetmask

Figure 75 – OpenVPN server profile settings

Username / Password Authentication

In the Username/Password section, enter the username and password you would like to use for authentication on the OpenVPN Server. Click the **Download CA certificate** or **Download CA TGZ depending on file format** button to save the **ca.crt** file. This file will need to be provided to the client.



Note: If you wish to have more than one client connect to this OpenVPN server, you must use Certificate authentication mode as Username/Password only allows for a single client connection.

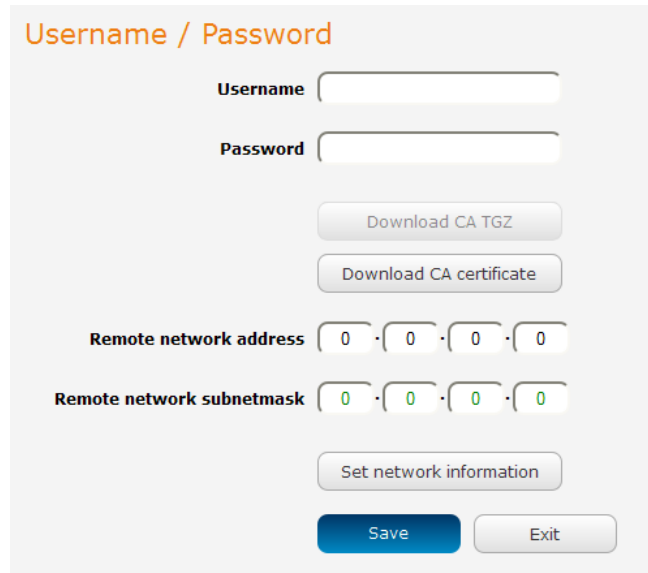

The screenshot shows a configuration page titled "Username / Password". It contains the following elements:

- Two text input fields: "Username" and "Password".
- Two buttons: "Download CA TGZ" and "Download CA certificate".
- Two sets of four input boxes each, labeled "Remote network address" and "Remote network subnetmask".
- A button labeled "Set network information".
- Two buttons at the bottom: "Save" (highlighted in blue) and "Exit".

Figure 76 - OpenVPN Server – Username / Password section

Optional: To inform the OpenVPN server of the network address scheme of the currently selected certificate, enter the network address and network subnet mask in the respective fields and click the **Set Network Information** button. If you do not enter the remote subnet here, any packet requests from the server to the client will not be received by the client network because it is not aware of the remote client's subnet.

When you have finished entering all the required information, click **Save** to finish configuring the OpenVPN server.

Configuring an OpenVPN Client

1. Click the **OpenVPN profile** toggle key to switch it to the **ON** position.
2. In the **Profile name** field, type a name for the OpenVPN client profile you are creating.
3. In the **Server IP** address field, type the WAN IP address /host domain name of the OpenVPN server.
4. Select OpenVPN connection type (TUN/TAP). Default is **TUN**.
5. Use the **Server** port field to select a port number and then use the drop down list to select a packet type to use for the OpenVPN server. The default OpenVPN port is 1194 and default packet type is UDP.
6. If the **Default gateway** option is applied on the OpenVPN client page, the OpenVPN server will enable connections to be made to other client networks connected to it. If it is not selected, the OpenVPN connection allows for secure communication links between this router and the remote OpenVPN server only.
7. Use the **Authentication type** options to select the Authentication type that you would like to use for the OpenVPN client.

Certificate Authentication

In the Certificate upload section at the bottom of the screen, click the **Browse** button and locate the certificate file you downloaded when you configured the OpenVPN server. When it has been selected, click the **Upload** button to send it to the router.

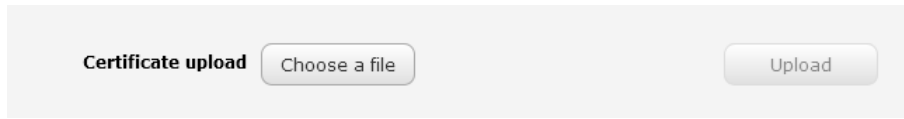

Figure 77 - OpenVPN client - Certificate upload

Username / Password Authentication

Enter the username and password to authenticate with the OpenVPN server.

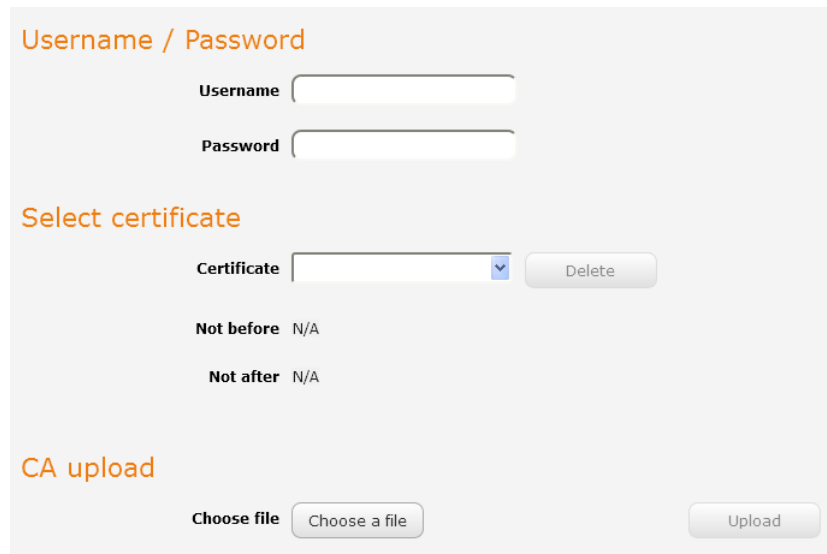

Figure 78 - OpenVPN Client - Username/Password section

Use the **Browse** button to locate the CA certificate file you saved from the OpenVPN Server and then press the **Upload** button to send it to the router.

Click the **Save** button to complete the OpenVPN Client configuration.

Configuring an OpenVPN P2P Connection

To configure an OpenVPN peer-to-peer connection:

1. Set the **OpenVPN** profile toggle key to switch it to the **ON** position.
2. In the **Profile name** field, type a name for the OpenVPN P2P profile you are creating.
3. On the router designated as the server, leave the **Server IP address** field empty. On the router designated as the client, enter the **WAN IP address/host domain name** of the server.

OpenVPN peer edit

OpenVPN profile ON OFF

Profile name

Server IP address
(leave empty if it's a peer-to-peer server)

Server port

Local IP address

Remote IP address

Remote network

Address

Subnet mask

Server secret key

Update time N/A

Client secret key

Update time N/A

Client secret key upload

Figure 79 - OpenVPN P2P mode settings

4. Use the **Server** port field to select a port number and then use the drop down list to select a packet type to use for the OpenVPN server. The default OpenVPN port is 1194 and default packet type is UDP.
5. In the **Local IP Address** and **Remote IP Address** fields, enter the respective local and remote IP addresses to use for the OpenVPN tunnel. The slave should have the reverse settings of the master.
6. Under the Remote network section, enter the network **Address** and network **Subnet mask**. The Network Address and Network Mask fields inform the Master node of the LAN address scheme of the slave.
7. Press the **Generate** button to create a secret key to be shared with the slave. When the timestamp appears, you can click the **Download** button to save the file to exchange with the other router.
8. When you have saved the secret key file on each router, use the **Browse** button to locate the secret key file for the master and then press the **Upload** button to send it to the slave. Perform the same for the other router, uploading the slave's secret key file to master.
9. When they are uploaded click the **Save** button to complete the peer-to-peer OpenVPN configuration.

PPTP client

The Point-to-Point Tunneling Protocol (PPTP) is a method for implementing virtual private networks using a TCP and GRE tunnel to encapsulate PPP packets. PPTP operates on Layer 2 of the OSI model and is included on Windows computers.

Configuring the PPTP client

To configure the PPTP client:

1. From the menu bar at the top of the screen, click **Networking** and then from the **VPN** section on the left side of the screen, click **PPTP client**. The PPTP client list is displayed.

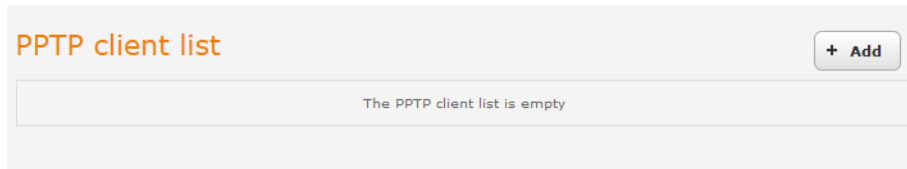

Figure 80 - PPTP client list

2. Click the **+Add** button to begin configuring a new PPTP client profile. The PPTP client edit screen is displayed.

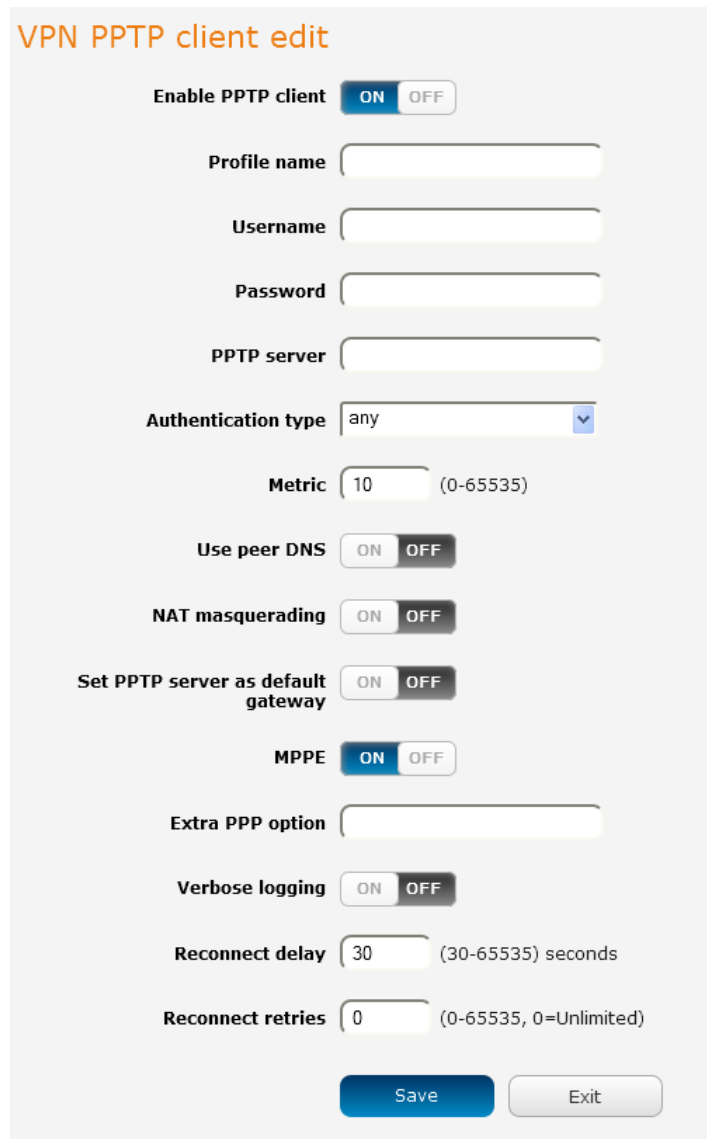

Figure 81 - VPN PPTP client edit

3. Click the **Enable PPTP client** toggle key to switch it to the **ON** position.
4. In the **Profile name list**, enter a profile name for the tunnel. This may be anything you like and is used to identify the tunnel on the router.
5. Use the **Username** and **Password** fields to enter the username and password for the PPTP account.
6. In the **PPTP server address** field, enter the IP address /host domain name of the PPTP server.
7. From the **Authentication type** drop down list, select the Authentication type used on the server. If you do not know the authentication method used, select **any** and the router will attempt to determine the correct authentication type for you. There are 5 authentication types you can choose from:
 - 🔌 CHAP – uses a three way handshake to authenticate the identity of a client.
 - 🔌 MS-CHAP v1 – This is the Microsoft implementation of the Challenge Handshake Authentication Protocol for which support was dropped in Windows® Vista.
 - 🔌 MS-CHAP v2 - This is the Microsoft implementation of the Challenge Handshake Authentication Protocol which was introduced in Windows® NT 4.0 and is still supported today.
 - 🔌 PAP – The Password Authentication Protocol uses a password as a means of authentication and as such, is commonly supported. PAP is not recommended because it transmits passwords unencrypted and is not secure.
 - 🔌 EAP – Extensible Authentication Protocol. An Authentication protocol commonly used in wireless networks.
8. The **metric** value helps the router to prioritise routes and must be a number between 0 and 65535. The default value is 30 and should not be modified unless you are aware of the effect your changes will have.
9. The **Use peer DNS** option allows you to select whether the remote clients will use the Domain Name Server of the PPTP server. Click the toggle key to set this to ON or OFF as required.
10. **NAT masquerading** allows the router to modify the packets sent and received to inform remote computers on the internet that packets originating from a machine behind the router actually originated from the WAN IP address of the router's internal NAT IP address. Click the toggle key to switch this to the ON position if you want to use this feature.
11. Set **default route to PPTP** sets all outbound data packets to go out through the PPTP tunnel. Click the toggle key to switch this to the ON position if you want to use this feature.
12. The **Verbose logging** option sets the router to output detailed logs regarding the PPTP connection in the **System Log** section of the router interface.
13. The **Reconnect delay** is the time in seconds that the router will wait before attempting to connect to the PPTP server in the event that the connection is broken. The minimum time to wait is 30 seconds so as to not flood the PPTP server with connection requests, while the maximum time to wait is 65535 seconds.
14. The **Reconnect retries** is the number of connection attempts that the router will make in the event that the PPTP connection goes down. If set to 0, the router will retry the connection indefinitely, otherwise the maximum number of times to retry cannot be greater than 65535.
15. Click the **Save** button to save the changes. The VPN will attempt to connect after your click Save. Click the **Status** button at the top left of the interface to return to the status window and monitor the VPN's connection state.

GRE tunnelling

The Generic Route Encapsulation (GRE) protocol is used in addition to Point-to-Point Tunnelling Protocol (PPTP) to create VPNs (virtual private networks) between clients and servers or between clients only. Once a PPTP control session establishes the VPN tunnel GRE is used to securely encapsulate the data or payload.

Configuring GRE tunnelling

To configure GRE tunnelling:

1. From the menu bar at the top of the screen, click **Networking** and then from the **VPN** section on the left side of the screen, click **GRE**. The GRE client list is displayed.



Figure 82 - GRE client list

2. Click the **+Add** button to begin configuring a new GRE tunnelling client profile. The GRE Client Edit screen is displayed.

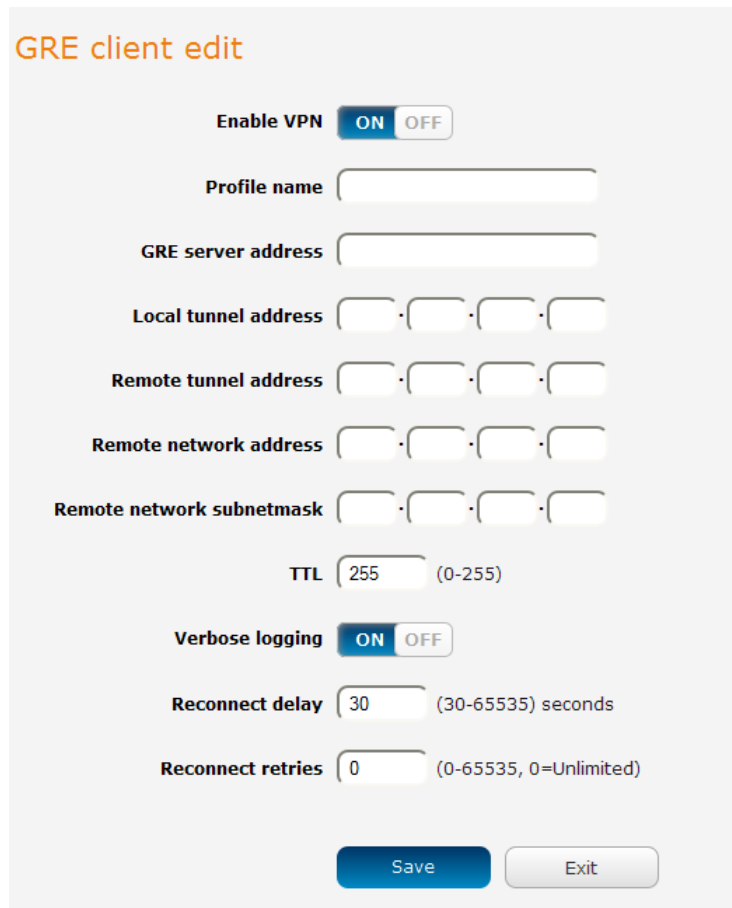

Figure 83 – GRE client edit

3. Click the **Enable GRE Tunnel** toggle key to switch it to the **ON** position.
4. In the **Profile name**, enter a profile name for the tunnel. This may be anything you like and is used to identify the tunnel on the router.
5. In the **GRE server address** field, enter the IP address or domain name of the GRE server.
6. In the **Local tunnel address** field, enter the IP address you want to assign the tunnel locally.
7. In the **Remote tunnel address** field, enter the IP address you want to assign to the remote tunnel.
8. In the **Remote network address** field, enter the IP address scheme of the remote network.
9. In the **Remote network subnetmask** field, enter the subnet mask of the remote network.
10. The **TTL** (Time To Live) field is an 8-bit field used to remove an undeliverable data packet from a network to avoid unnecessary network traffic across the internet. The default value of 255 is the upper limit on the time that an IP datagram can exist. The value is reduced by at least one for each hop the data packet takes to the next router on the route to the datagram's destination. If the TTL field reaches zero before the datagram arrives at its destination the data packet is discarded and an error message is sent back to the sender.
11. The **Verbose logging** option sets the router to output detailed logs regarding the GRE tunnel in the **System Log** section of the router interface.
12. The **Reconnect delay** is the time in seconds that the router will wait before attempting to connect to the GRE server in the event that the connection is broken. The minimum time to wait is 30 seconds so as to not flood the GRE server with connection requests, while the maximum time to wait is 65335 seconds.
13. The **Reconnect retries** is the number of connection attempts that the router will make in the event that the GRE connection goes down. If set to 0, the router will retry the connection indefinitely, otherwise the maximum number of times to retry cannot be greater than 65335.
14. Click the **Save** button to save the changes. The VPN will attempt to connect after your click Save. Click the **Status** button at the top left of the interface to return to the status window and monitor the VPN's connection state.

Services

Dynamic DNS

The DDNS page is used to configure the Dynamic DNS feature of the router. A number of Dynamic DNS hosts are available from which to select. To access the Dynamic DNS page, click on the **Services** menu at the top of the screen then click on the **Dynamic DNS** menu item on the left.

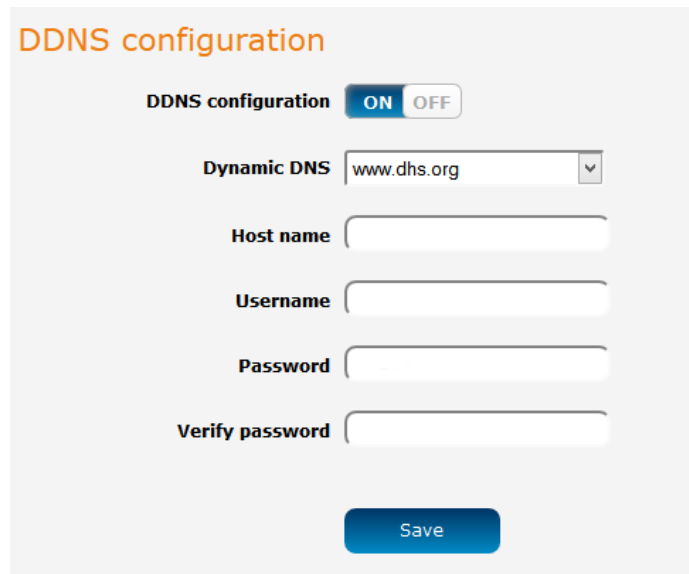









Figure 84 – Dynamic DNS settings

Dynamic DNS provides a method for the router to update an external name server with the current WAN IP address.

To configure dynamic DNS:

1. Click the **DDNS configuration** toggle key to switch it to the ON position.
2. From the **Dynamic DNS** drop down list, select the Dynamic DNS service that you wish to use. The available DDNS services available are:
 -  www.dhs.org
 -  www.dyndns.org
 -  www.dyns.cx
 -  www.easydns.com
 -  www.justlinux.com
 -  www.ods.org
 -  www.tzo.com
 -  www.zoneedit.com
3. Enter your hostname in 'Host name' field.
4. In the **Username** and **Password** fields, enter the logon credentials for your DDNS account. Enter the password for the account again in the **Verify password** field.
5. Click the **Save** button to save the DDNS configuration settings.

Network time (NTP)

The NTP (Network Time Protocol) settings page allows you to configure the NTC-140W Series router to synchronize its internal clock with a global Internet Time server and specify the time zone for the location of the router. This provides an accurate timekeeping function for features such as System Log entries and Firewall settings where the current system time is displayed and recorded. Any NTP server available publicly on the internet may be used. The default NTP server is 0.netcomm.pool.ntp.org.

To access the Network time (NTP) page, click on the **Services** menu at the top of the screen then click on the **Network time (NTP)** menu item on the left.

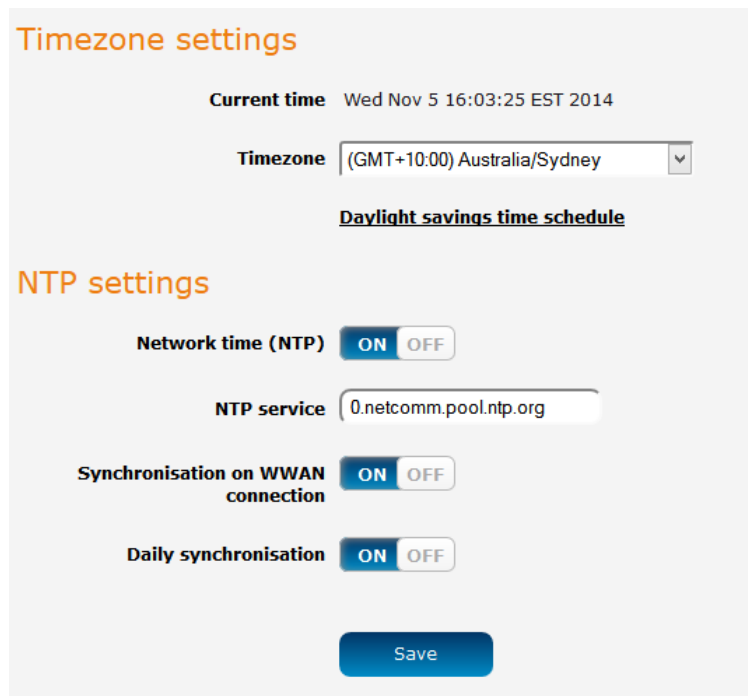

Figure 85 - NTP settings

Configuring Timezone settings

To configure time zone settings:

1. The **Current time** field shows the time and date configured on the router. If this is not accurate, use the **Time zone** drop down list to select the correct time zone for the router. If the selected zone observes daylight savings time, a **Daylight savings time schedule** link appears below the drop down list. Click the link to see the start and end times for daylight savings.
2. When you have selected the correct time zone, click the **Save** button to save the settings.

Configuring NTP settings

To configure NTP settings:

1. Click the **Network time (NTP)** toggle key to switch it to the **ON** position.
2. In the **NTP service** field, enter the address of the NTP server you wish to use.
3. The **Synchronization on WWAN connection** toggle key enables or disables the router from performing a synchronization of the time each time a mobile broadband connection is established.
4. The **Daily synchronisation** toggle key enables or disables the router from performing a synchronization of the time each day.
5. When you have finished configuring NTP settings, click the **Save** button to save the settings.

Data stream manager







The data stream manager provides you with the ability to create mappings between two endpoints on the router. These endpoints may be physical or virtual, for example, a serial port connected to the router’s USB port could be configured as an endpoint or you could configure a TCP Server as an endpoint. You can then configure a virtual data tunnel or “stream” between the endpoints.

The data stream manager provides a wide range of possibilities and expands upon simple PAD functionality to include the forwarding and translation of data between any of the endpoints. For example, you could send the GPS data from the built-in module to a TCP server running on the router. In each case, the logical flow of the stream is from Endpoint A to Endpoint B.

Customers interested in developing their own applications to create custom endpoints and streams can contact NetComm Wireless about our Software Development Kit.

Endpoints

The first thing to be done in order to create a data stream is to define the endpoints. There are 6 types of endpoint that may be configured:

-  Serial port (generic)
-  TCP Server
-  TCP Client
-  UDP Server
-  UDP Client
-  GPS Data (for devices with GPS receiver)
-  User defined executable

To access the Endpoints page, click on the **Services** menu at the top of the screen, click on the **Data stream manager** menu then click on the **Endpoint** menu item on the left.

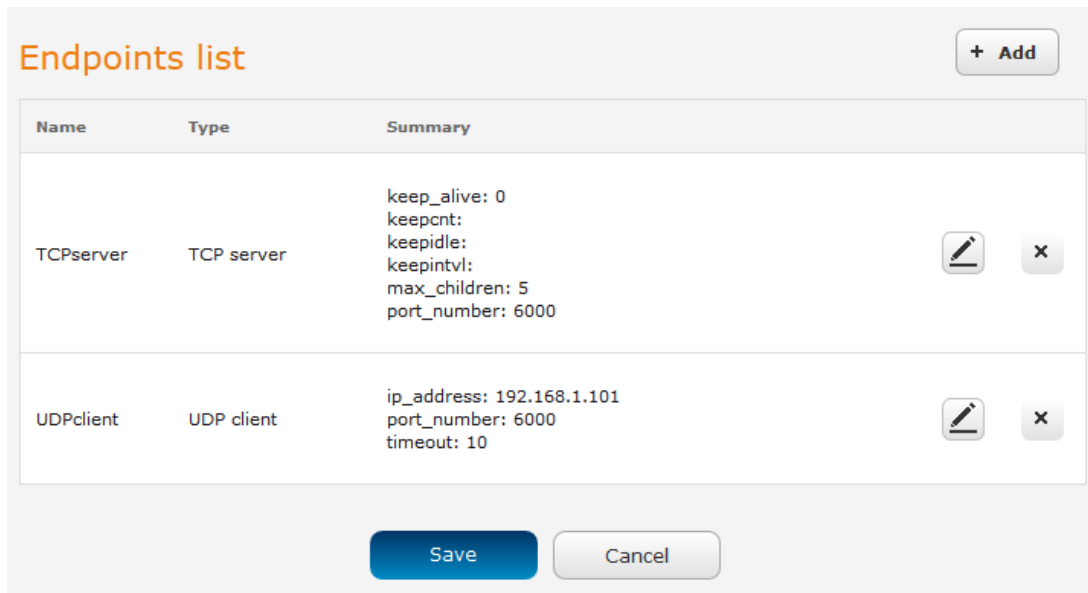

Figure 86 - Endpoints list

To create an endpoint:

1. Click the **+Add** button on the right side of the page. A pop-up window appears.

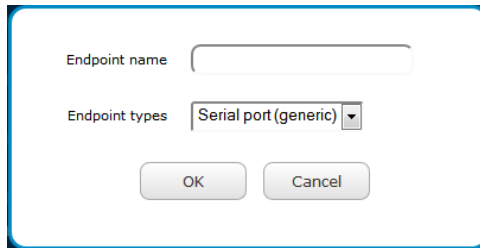

Figure 87 - Creating an endpoint

2. In the **Endpoint name** field, type a name for this endpoint. The name can contain alphanumeric characters only i.e. A-Z, a-z, 0-9.
3. Use the **Endpoint types** drop down list to select the type of endpoint to configure.

Serial port (generic): When a USB to Serial cable is used, this creates a generic serial port as an endpoint defaulting to the commonly used settings as shown below.

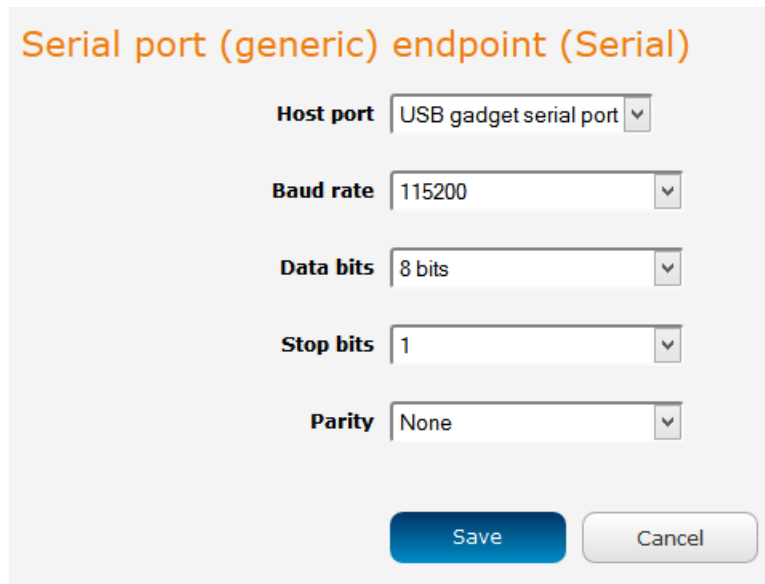

Figure 88 - Serial port (generic) endpoint configuration

TCP server: This creates a TCP server endpoint with the following options available.

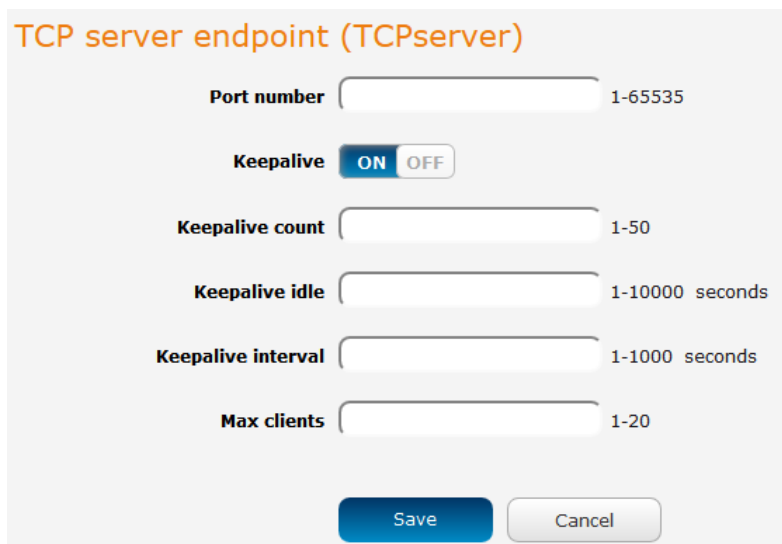

Figure 89 - TCP server endpoint configuration

TCP client: This creates a TCP client endpoint with the following options available. The retry timeout period specifies the number of seconds to wait between attempts to re-establish a connection in the event that it is lost. The client will attempt re-connection indefinitely every Retry timeout interval.

TCP client endpoint (TCPclient)

IP address

Port number 1-65535

Keepalive ON OFF

Keepalive count 1-50

Keepalive idle 1-10000 seconds

Keepalive interval 1-1000 seconds

Retry timeout 0-1000 seconds (0 = No retry)

Figure 90 - TCP client endpoint configuration

UDP server: This creates a UDP server endpoint with the following options available.

UDP server endpoint (UDPserver)

Port number 1-65535

Max clients 1-20

Figure 91 - UDP server endpoint configuration

UDP client: This creates a UDP client endpoint with the following options available. The retry timeout period specifies the number of seconds to wait between attempts to re-establish a connection in the event that it is lost. The client will attempt re-connection indefinitely every Retry timeout interval.

UDP client endpoint (UDPclient)

IP address

Port number 1-65535

Retry timeout 0-1000 seconds (0 = No retry)

Figure 92 - UDP client endpoint configuration

GPS data: This creates a GPS data endpoint.



Figure 93 - GPS data endpoint configuration

User defined executable: Allows you to specify an executable and parameters to be used as an endpoint. For example, the following executable reads the phone module temperature every second.

```
while true; do rdb_get wwan.0.radio.temperature; sleep 1; done
```

The temperature can then be sent to another endpoint.



Figure 94 – User defined executable endpoint configuration

4. Click the **OK** button. The router displays a screen with configuration options for your chosen endpoint type.
5. Enter the options for your endpoint as required.
6. Click the **Save** button. The Endpoints list is displayed with the newly created endpoint listed and a summary of the settings your configured.

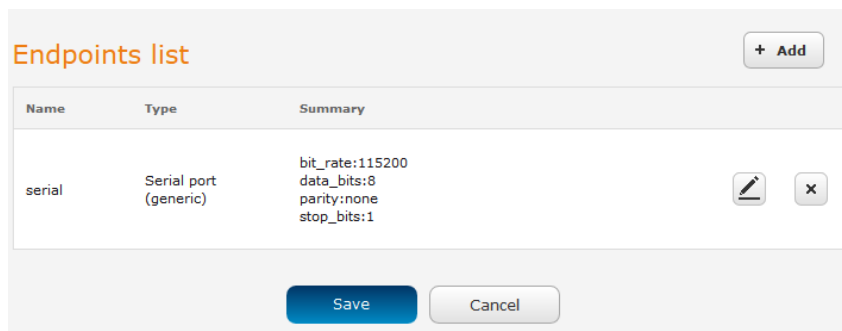

Figure 95 - Endpoints list

Streams

When you have created the required endpoints, you can then proceed to set up a data stream. A data stream sends data from one endpoint to another, performing any transformation of the data as required. When a stream is added, an underlying process on the router checks the validity of the stream, checking for conflicts and illogical configurations. To access the Streams page, click on the **Services** menu at the top of the screen, click on the **Data stream manager** menu then click on the **Streams** menu item on the left.



Notes on data stream operation:

- When any changes to the Data stream manager configuration are detected, all data streams are stopped and restarted as per the new configuration.
- Multiple Modbus clients cannot connect simultaneously to Modbus serial slaves connected to the router.

Every stream requires two endpoints, Endpoint A and Endpoint B. In all cases, the flow of data is from Endpoint A to Endpoint B.

To create a new stream:

1. Click the **+Add** button on the right side of the page.



Figure 96 - Data stream list

The Edit data stream page is displayed.

2. In the **Data stream name** field, enter a name for the Data stream.
3. Under Endpoint A, use the **Endpoint name** drop down list to select one of the endpoints you created previously. This endpoint should be the starting point of the stream. Use the **Mode** drop down list to select the mode of operation of the endpoint. The mode can be thought of as a transformation of the data as it leaves this endpoint. For example, if Endpoint A type is Serial port (generic), the Mode can be set to various Modbus server and client types. This means that upon arrival at Endpoint A, the data will be transformed into the chosen Modbus format, ready to be sent to Endpoint B.
4. Under Endpoint B, use the **Endpoint name** drop down list to select one of the endpoints you created previously. This endpoint should be the destination of the stream. The screenshot below shows a configuration sending data received on an attached serial port to a TCP server running on the router. Use the **Mode** drop down list to select the mode of operation of the endpoint. The mode can be thought of as a transformation of the data as it arrives at this endpoint.

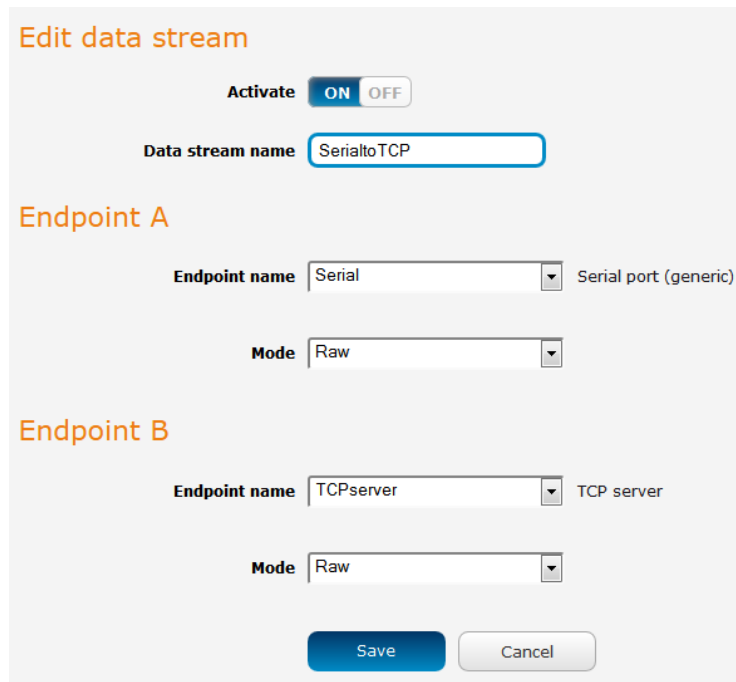

Figure 97 - Edit data stream

5. Click the **Save** button. The new stream appears in the Data stream list.

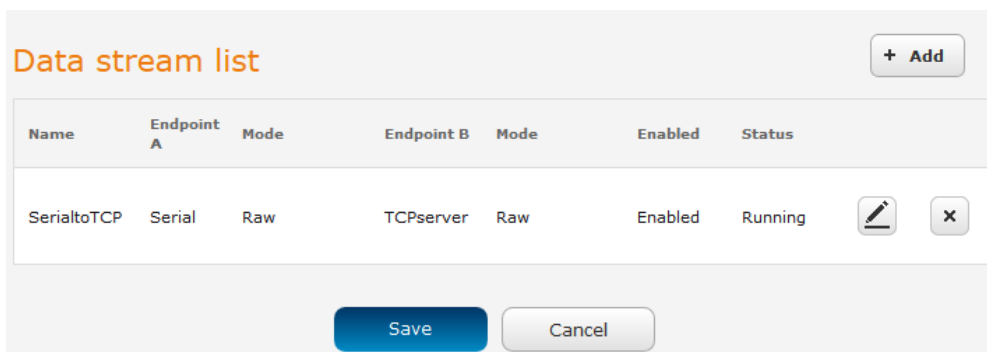

Figure 98 - Data stream list.

PADD

PAD Daemon is a tool used to encapsulate raw serial data into a TCP packet to be transported over IP to another end point. The server receiving the TCP packets unpacks the data and the original raw serial data is passed out of its serial port to the attached device, thereby creating an invisible IP network to the two serial devices.

The PAD Daemon runs as a background process which can be accessed via the web configuration interface. The PADD configuration page is located under “Services > PADD”. The PADD is used usually with multiple connections or when redundant connections are needed. The PADD has two modes: the PADD TCP/IP Server mode and PADD TCP/IP Client Mode. When PADD is enabled, both the PADD server mode and PADD client mode can be run at the same time.

To access the PADD configuration page, click on the **Services** menu at the top of the screen then click on the **PADD** menu item on the left.

PADD

Activate ON OFF

Serial port status No conflicts

Debug level (0-2)

Serial port settings

Host port External serial port (gadget-tty-musb-ti81xx)

Baud rate 115200

Data bits 8 bits

Stop bits 1

Parity None

Flow control Off

Inter character timeout (x100ms)

End-of-line character ASCII code

Start of line timestamps Off YYYYMMDDHHMMSS

TCP/IP Server

Listening port 1-65535

Incoming connection is Exclusive Shared

TCP/IP Client

Connect to First available All available

Remote Host 1 Server:Port

Remote Host 2 Server:Port

Remote Host 3 Server:Port

Remote Host 4 Server:Port

Network

Remote server retry period 1-65535 seconds

TCP Keepalive Probes 0-65535 seconds (0=disabled)

Number of probe failures before disconnect 1 - 20

Figure 99 - PADD

SNMP

SNMP configuration

The SNMP page is used to configure the SNMP features of the router. To access the SNMP configuration page, click on the **Services** menu at the top of the screen then click on the **SNMP** menu item on the left.

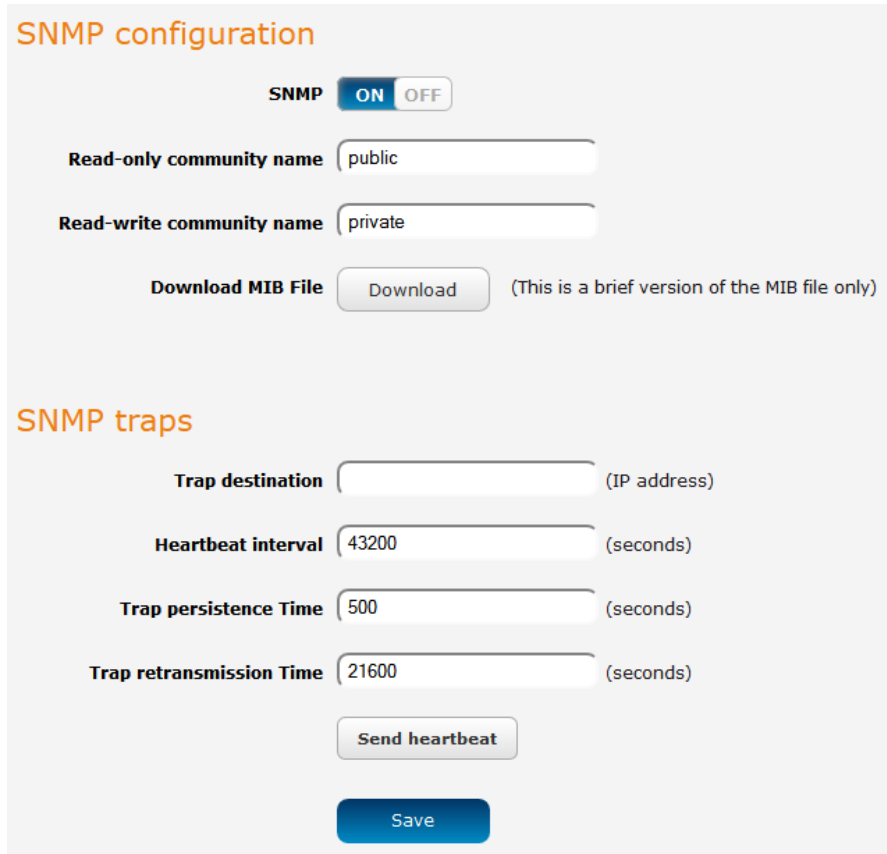

SNMP configuration

SNMP ON OFF

Read-only community name

Read-write community name

Download MIB File (This is a brief version of the MIB file only)

SNMP traps

Trap destination (IP address)

Heartbeat interval (seconds)

Trap persistence Time (seconds)

Trap retransmission Time (seconds)

Figure 100 - SNMP configuration

SNMP (Simple Network Management Protocol) is used to remotely monitor the router for conditions that may warrant administrative attention. It can be used to retrieve information from the router such as the signal strength, the system time and the interface status.

To configure SNMP:

1. Click the **SNMP** toggle key to switch it to the **ON** position.
2. Enter **Read-only community name** and **Read-write community name** which are used for client authentication.



Community names are used as a type of security to prevent access to reading and/or writing to the routers configuration. It is recommended that you change the Community names to something other than the default settings when using this feature.

3. Click the **Save** button to save any changes to the settings.

The **Download** button displays the Management Information Base (MIB) of the router. The MIB displays all the objects of the router that can have their values set or report their status. The MIB is formatted in the SNMP-related standard RFC1155.

SNMP traps

SNMP traps are messages from the router to the Network Management System sent as UDP packets. They are often used to notify the management system of any significant events such as whether the link is up or down.

Configuring SNMP traps

To configure SNMP traps:

1. In the **Trap destination** field, enter the IP address to which SNMP data is to be sent.
2. In the **Heartbeat interval** field, enter the number of seconds between SNMP heartbeats.
3. Use the **Trap persistence** field to specify the time in seconds that an SNMP trap persists.
4. Use the **Trap retransmission** time to specify the length of time in seconds between SNMP trap retransmissions.

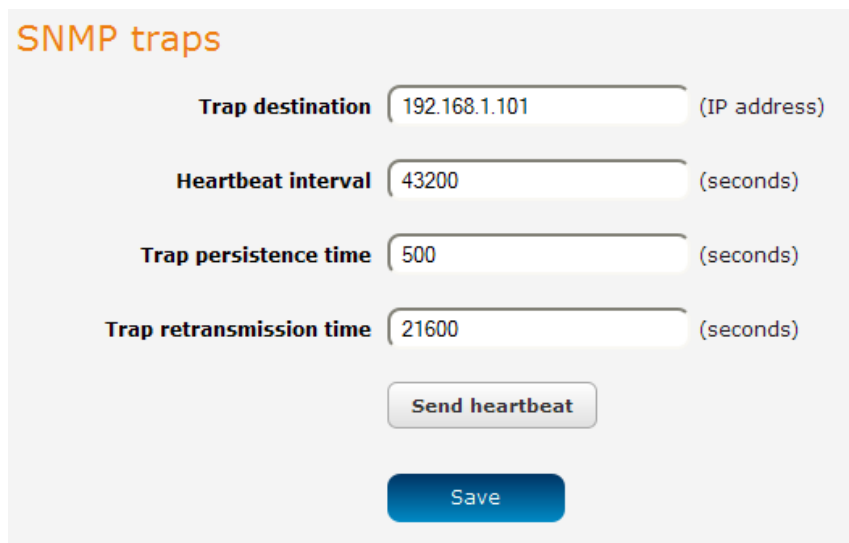

SNMP traps

Trap destination (IP address)

Heartbeat interval (seconds)

Trap persistence time (seconds)

Trap retransmission time (seconds)

Figure 101 - SNMP traps

To send a manual SNMP Heartbeat, click the **Send heartbeat** button. When you have finished configuring the SNMP traps, click the **Save** button to save the settings.



Note: When a factory reset is performed via SNMP, the SNMP settings are preserved.

TR-069

To access the TR-069 configuration page, click the **Services** menu item, then select the TR-069 menu item on the left.

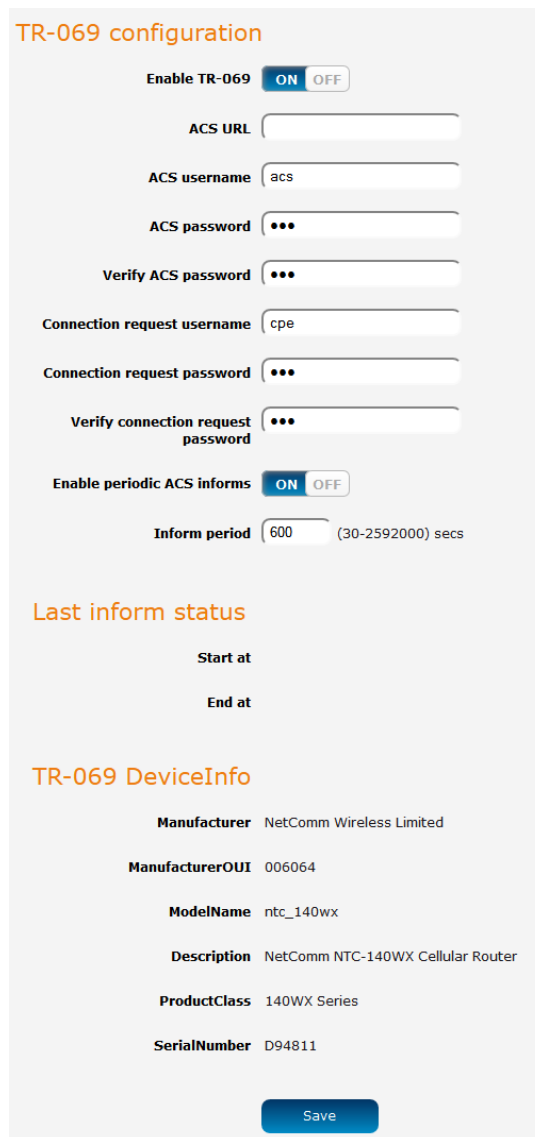





Figure 102 - TR-069 configuration

The TR-069 (Technical Report 069) protocol is a technical specification also known as CPE WAN Management Protocol (CWMP). It is a framework for remote management and auto-configuration of end-user devices such as customer-premises equipment (CPE) and Auto Configuration Servers (ACS). It is particularly efficient in applying configuration updates across networks to multiple CPEs.

TR-069 uses a bi-directional SOAP/HTTP-based protocol based on the application layer protocol and provides several benefits for the maintenance of a field of CPEs:

-  Simplifies the initial configuration of a device during installation
-  Enables easy restoration of service after a factory reset or replacement of a faulty device
-  Firmware and software version management
-  Diagnostics and monitoring

Note:



- You must have your own compatible ACS infrastructure to use TR-069. In order to access and configure the TR-069 settings you must be logged into the router as the root user.
- When a factory reset of the router is performed via TR-069, the TR-069 settings are preserved.

The NetComm Wireless router sends “inform” messages periodically to alert the ACS server that it is ready. These inform messages can also be configured to accept a connection request from the ACS server. When a connection is established, any tasks queued on the ACS server are executed. These tasks may be value retrieval or changes and firmware upgrades.

TR-069 configuration

To configure TR-069:





1. Click the **Enable TR-069** toggle key to switch it to the **ON** position.
2. In the **ACS URL** field, enter the Auto Configuration Server’s full domain name or IP address.
3. Use the **ACS username** field to specify the username used by the server to authenticate the CPE when it sends an “inform” message.
4. In the **ACS password** and **Verify ACS password** fields, enter the password used by the server to authenticate the CPE when it sends an “inform” message.
5. In the **Connection Request Username** field, enter the username that the CPE uses to authenticate the Auto Configuration Server during a connection request to the CPE.
6. In the **Connection Request Password** and **Verify password** fields, enter the password that the CPE uses to authenticate the Auto Configuration Server during a connection request to the CPE.
7. The inform message acts as a beacon to inform the ACS of the existence of the router. Click the **Enable periodic ACS informs** toggle key to turn on the periodic ACS inform messages.
8. In the **Inform Period** field, enter the number of seconds between the inform messages.
9. Click the **Save** button to save the settings.

GPS

On models with a built-in GPS, you are able to use location-based services, monitor field deployed hardware or find your current location. The GPS Status window provides up to date information about the current location and the current GPS signal conditions (position dilution of precision (PDOP), horizontal dilution of precision (HDOP) and vertical dilution of precision (VDOP)) of the router.

NMEA support

The router supports the National Marine Electronics Association NMEA-0183 compatible (V2.3) standard of sending GPS data. The standard includes “sentences” used to identify the type of data being sent and therefore defines the way the data is interpreted. The supported GPS related sentences are listed below:

-  GPGGA – Global Positioning System Fix Data, Time, Position and fix related data for a GNSS receiver
-  GPRMC – Recommended minimum data for GPS
-  GPGSV – Detailed satellite data
-  GPGSA – Overall satellite data
-  GPVTG – Vector track and speed over the Ground

GPS configuration

To access the GPS configuration screen, select the **Services** item from the top menu bar then the **GPS** item on the left. Finally, select the **GPS configuration** menu item.

To use the GPS function, set the **GPS operation** toggle key to **ON** and click the **Save** button.

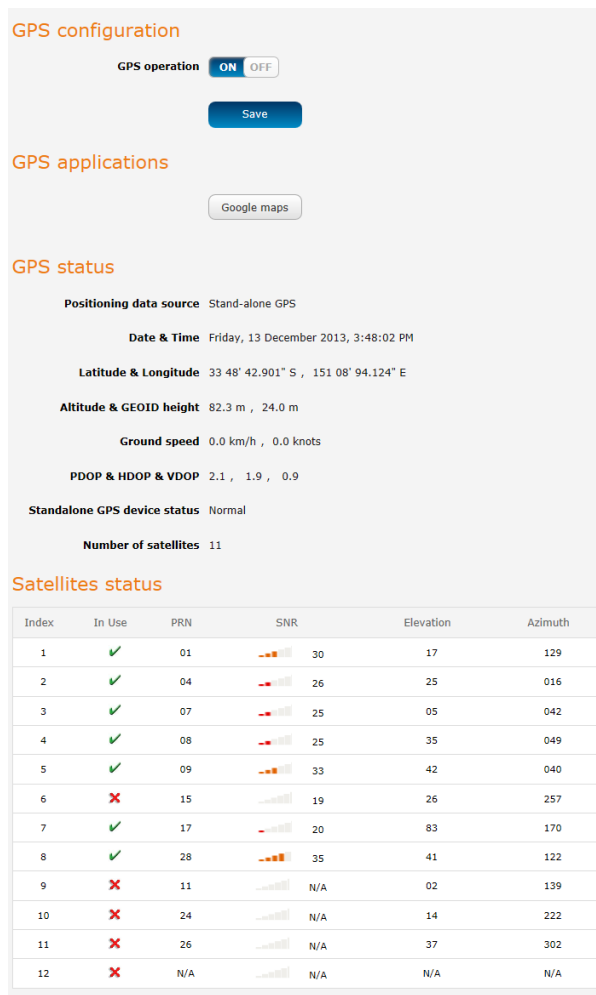

GPS configuration

GPS operation **ON** OFF

Save

GPS applications

Google maps

GPS status

Positioning data source Stand-alone GPS

Date & Time Friday, 13 December 2013, 3:48:02 PM

Latitude & Longitude 33 48' 42.901" S , 151 08' 94.124" E

Altitude & GEOD height 82.3 m , 24.0 m

Ground speed 0.0 km/h , 0.0 knots

PDOP & HDOP & VDOP 2.1 , 1.9 , 0.9

Standalone GPS device status Normal

Number of satellites 11

Satellites status

Index	In Use	PRN	SNR	Elevation	Azimuth
1	✓	01	30	17	129
2	✓	04	26	25	016
3	✓	07	25	05	042
4	✓	08	25	35	049
5	✓	09	33	42	040
6	✗	15	19	26	257
7	✓	17	20	83	170
8	✓	28	35	41	122
9	✗	11	N/A	02	139
10	✗	24	N/A	14	222
11	✗	26	N/A	37	302
12	✗	N/A	N/A	N/A	N/A

Figure 103 – GPS configuration

The **Google maps** button provides a quick short cut to show your router’s current position on a map.

Odometer

To access the Odometer screen, select the **Services** item from the top menu bar then the **GPS** item on the left. Finally, select the **Odometer** menu item.

The GPS may be used to record the distance that the router has travelled. To do this, set the **Odometer** toggle key to the **ON** position as in the screenshot below. You can toggle the unit of measurement by clicking the **Display imperial / Display metric** button. The threshold setting adjusts the router's sensitivity to movement so that movement within the specified radius from the starting point does not register as distance travelled. When you have finished configuring the Odometer settings, click the **Save** button to ensure the settings are stored on the router.

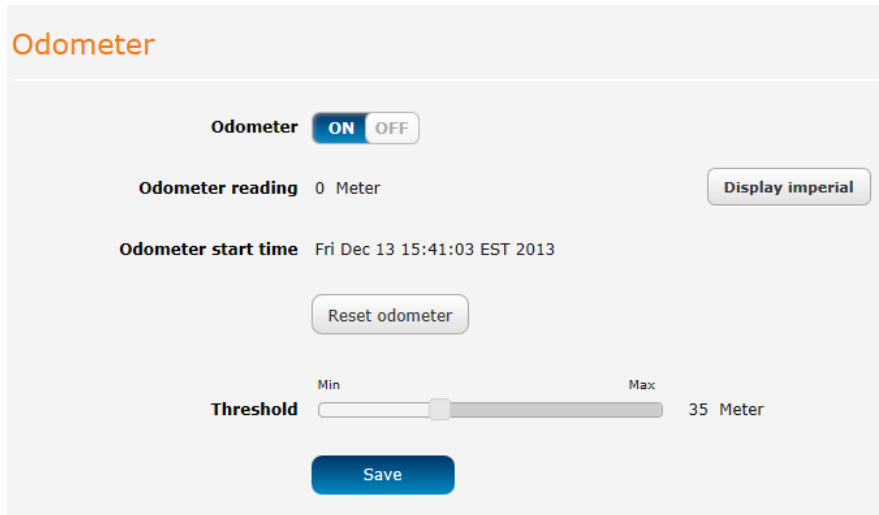







Figure 104 – Odometer options

ITEM	DESCRIPTION
Odometer reading	The number of metres/kilometres that the device has travelled since the time listed in the Odometer start time field.
Display imperial / Display metric	Toggles the Odometer reading between metric and imperial measurements.
Odometer start time	The time that recording of distance travelled began.
Reset odometer	Resets the odometer reading to 0 and the Odometer start time to the current time.
Odometer	Toggles the Odometer function on and off.
Threshold	Specifies the minimum distance that the router must travel from its current position before the Odometer reading increases.

Table 24 - Odometer configuration options

IO configuration

The NTC-140W Series Router is equipped with a 2 x 2 Molex connector providing Power (+), Ground (-), a multipurpose input and output pin and an ignition detection input. The multipurpose input/output pin may be independently configured for various functions, including:

-  NAMUR (EN 60947-5-6 / IEC 60947-5-6) compatible proximity sensor input
-  Proximity sensor input for use with contact closure (open/closed) type of sensors (PIR sensors, door/window sensors for security applications) with the input tamper detection possible (four states detected: open, closed, short and break) by the use of external resistors
-  Analogue 0V to 30V input
-  Digital input (the I/O voltage measured by the Analogue input and the software making decision about the input state) with the threshold levels configurable in software
-  Open collector output.

Use the pull up voltage options to select the desired output voltage of the I/O pins. The pull up voltage you select will be the same for each pin when pull up is enabled for that pin. Each pin is capable of outputting either 3.3V or 8.2V.

To access the IO configuration page, click the **Services** menu item, then select the **IO configuration** menu item on the left.

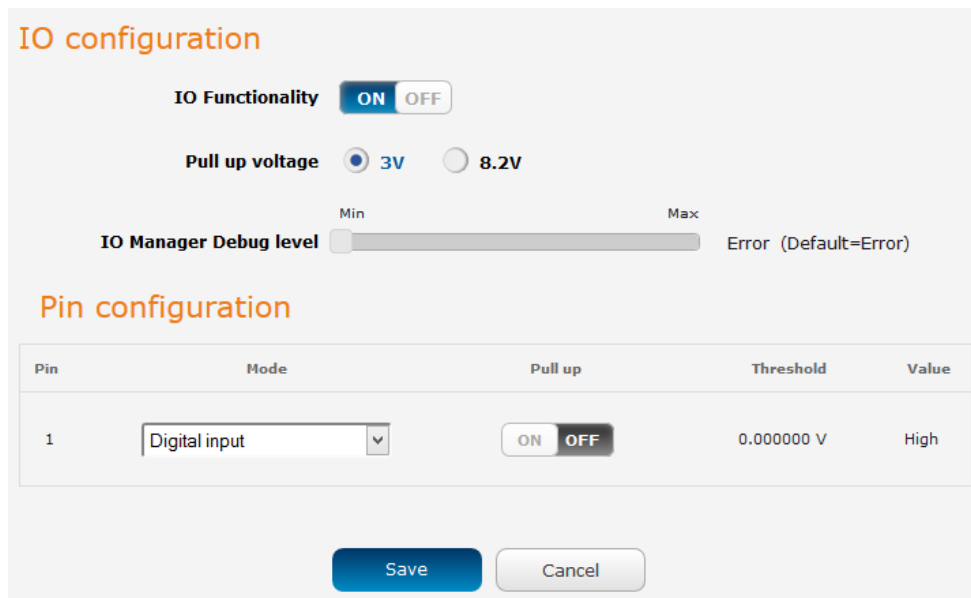

Figure 105 – IO configuration options

ITEM	DESCRIPTION
IO configuration	
IO Functionality	Enables the configuration of the input and output pins on the 2x2 Molex connector.
Pull up voltage	Specifies the output voltage of the I/O pins.
IO Manager Debug level	Use the slide bar to adjust the level of detail you would like to see in the log for IO messages. A higher debug level displays more detailed messages in the log file.
Per pin configuration	
Pin	The I/O pin number corresponding to the pin on the Molex connector that you wish to configure.
Mode	The mode of operation for the corresponding pin. Available options are Digital input, Digital output, Analogue input, Namur input, Contact closure input.
Pull up	Use the pull up toggle keys to turn the pull up on or off for the corresponding pin. When turned on, the pull up voltage output is the value specified in the "Pull up voltage" option.
Threshold	Displays the current voltage threshold configured for the I/O pin.
Value	The value column displays whether the voltage detected on the line is low or high or allows you to configure the output value in the case that the pin is set to digital output. This can be useful for applications where monitoring of the transition between low and high is used to trigger an action.

Table 25 - IO configuration options

The table below describes the different modes available on the physical I/O pins of the router.

MODE	DESCRIPTION
Digital input	The corresponding pin accepts digital input. Pull up may be on or off and both 3.3V and 8.2V are available as pull up voltages. The value column displays whether the signal received on the pin is High or Low.
Digital output	The corresponding pin outputs a digital signal. Pull up may be on or off and both 3.3V and 8.2V are available as pull up voltages. The value column contains a toggle key allowing you to set whether the output signal is High or Low.
Analogue input	The corresponding pin accepts an analogue signal. Pull up may be on or off and both 3.3V and 8.2V are available as pull up voltages. The value column displays the current voltage detected on the pin.
Namur input	NAMUR is a sensor standard using low-level current signals. It can supply two different signal levels depending on the state of the switch and is commonly used in hazardous or explosive locations where compact sensors are required. When a pin is set to NAMUR mode, Pull up is turned on and the global Pull up voltage is set to 8.2V. These settings may not be changed for as long as a pin is set to NAMUR mode as they are required settings according to the NAMUR IEC 60947-5-6 standard. The value column displays whether the signal received on the pin is High or Low.
Contact closure input	A common type of digital input where a sensor or switch opens or closes a set of contacts as a result of a process change. An electrical signal is then used to determine whether the circuit is open or closed. When a pin is set to Contact closure input, Pull up is enabled for that pin and may not be turned off as long as the pin remains configured as a Contact closure input. Global pull up voltage may be either 3.3V or 8.2V.

Table 26 - IO pin modes



Note: Please refer to the SDK Developer Guide for hardware information about the Input/Output pins, wiring examples and configuration of the pins via the command line interface. There are also wiring examples in Appendix G of this User Guide. Contact NetComm Wireless Technical Support for access to the Software Development Kit.

Event notification

The event notification feature is an advanced remote monitoring tool providing you with the ability to send alerts via SMS, e-mail, TCP or UDP when pre-defined system events occur.

Notification configuration

The Notification configuration screen is used to select the event types, methods of notification and the destinations for the notifications. Up to four types of alerts for a particular event may be sent to a single destination profile containing the contact details.

To access the Event notification configuration page, click the **Services** menu item, select the **Event configuration** menu item on the left, then select the **Notification configuration** menu item.

Event notification configuration

Enable event notification ON OFF

Maximum event buffer size (100-10000)

Maximum retry count (1-20)

Event notification log file

Unit ID

Event description	Event ID	Email	TCP	UDP	SMS	Destination profile
Unit powered up	1	<input type="checkbox"/>	<input type="checkbox"/>	<input type="checkbox"/>	<input type="checkbox"/>	Default <input type="button" value="v"/>
Unit rebooted	2	<input type="checkbox"/>	<input type="checkbox"/>	<input type="checkbox"/>	<input type="checkbox"/>	Default <input type="button" value="v"/>
Link status change	3	<input type="checkbox"/>	<input type="checkbox"/>	<input type="checkbox"/>	<input type="checkbox"/>	Default <input type="button" value="v"/>
WWAN IP address change	4	<input type="checkbox"/>	<input type="checkbox"/>	<input type="checkbox"/>	<input type="checkbox"/>	Default <input type="button" value="v"/>
WWAN Registration change	5	<input type="checkbox"/>	<input type="checkbox"/>	<input type="checkbox"/>	<input type="checkbox"/>	Default <input type="button" value="v"/>
WWAN Cell ID change	6	<input type="checkbox"/>	<input type="checkbox"/>	<input type="checkbox"/>	<input type="checkbox"/>	Default <input type="button" value="v"/>
WWAN technology change	7	<input type="checkbox"/>	<input type="checkbox"/>	<input type="checkbox"/>	<input type="checkbox"/>	Default <input type="button" value="v"/>
Number of connected Ethernet interfaces change	8	<input type="checkbox"/>	<input type="checkbox"/>	<input type="checkbox"/>	<input type="checkbox"/>	Default <input type="button" value="v"/>
Web UI login failure	10	<input type="checkbox"/>	<input type="checkbox"/>	<input type="checkbox"/>	<input type="checkbox"/>	Default <input type="button" value="v"/>
SD card status changed	11	<input type="checkbox"/>	<input type="checkbox"/>	<input type="checkbox"/>	<input type="checkbox"/>	Default <input type="button" value="v"/>
WAN failover instance occurred	12	<input type="checkbox"/>	<input type="checkbox"/>	<input type="checkbox"/>	<input type="checkbox"/>	Default <input type="button" value="v"/>
WiFi clients number changed	13	<input type="checkbox"/>	<input type="checkbox"/>	<input type="checkbox"/>	<input type="checkbox"/>	Default <input type="button" value="v"/>

Figure 106 - Event notification configuration

ITEM	DESCRIPTION
Enable event notification	Toggles the event notification feature on and off.
Maximum event buffer size	Specifies the buffer size for event notifications which failed to be delivered or are yet to be sent. The minimum size is 100 and the maximum is 10000.
Maximum retry count	Specifies the maximum number of attempts that the router will make to deliver an event notification. The range is between 1 and 20.
Event notification log file	Specifies to the location and name of the file used to log the event notification activity.
Event notification prefix	The Unit ID field is used to specify an identifier for the router which are sent in the event notifications so that you know which router has an event.

Table 27 - Event notification configuration options

Event types

There are ten events for which you can configure alerts. Hovering the mouse over the event description provides more details of event notification type.

EVENT	EVENT ID	DESCRIPTION
Unit powered up	1	Notification is sent when the unit is powered up through connection of a power source or after a soft-reset.
Unit rebooted	2	Notification is sent when the unit is rebooted via Web UI, SMS diagnostics or via command line/telnet session.
Link status change	3	Notification is sent if the status of the data connection profile or any IPSec/OpenVPN/PPTP/GRE tunnel endpoint changes i.e. the link goes up or down.
WWAN IP address change	4	Notification is sent if an active data connection profile's WWAN IP address changes.
WWAN Registration change	5	Notification is sent if the network registration status changed between "registered", "unregistered" or "roaming".
WWAN Cell ID change	6	Notification is sent if the router connects to a different cell, marked by a changed in the Cell ID.
WWAN technology change	7	Notification is sent if the router connects to a different network technology, e.g. 3G/2G.
Number of connected Ethernet interfaces change	8	Notification is sent if there is a change to the number of directly connected Ethernet interfaces.
Web UI login failure	10	Notification is sent if there was a failure to log in to the router via the Web UI.
SD card status changed	11	Notification is sent if the status of the SD card changes, i.e. a card is removed or inserted.
WAN failover instance occurred	12	Notification is sent if a failover between WAN interfaces occurs.
WiFi clients number changed	13	Notification is sent if the number of connected WiFi clients changes.

Table 28 - Event notification – event types

Destinations

A "destination" is a profile on the router containing the contact details of a recipient of event notification alerts i.e. the e-mail address, SMS number, TCP or UDP server addresses of the recipient. The destination profile must contain the details of at least one destination type in order to be used.

Configuring Event notification

To configure the event notification feature:

1. Click the Services menu item at the top of the screen. From the Event notification menu on the left of the screen, select the **Destination configuration** menu item.
2. Click the **+Add** button at the top right corner of the window. The Event destination edit screen is displayed.
3. In the **Destination name** field enter a name for the destination profile then enter the contact details for the each type of destination i.e. Email address, TCP address and port, UDP address and port and/or SMS number.
4. Click the **Save** button when you have entered the required details.
5. From the Event notification menu on the left of the screen, select the **Notification configuration** menu item.
6. Select the **Enable event notification** toggle key to turn it to the **ON** position.
7. If desired, set the **Maximum event buffer size**, **Maximum retry count**, **Event notification log file** and **Event notification prefix** fields. See table 23 for descriptions of these options.
8. From the **Destination** column, use the drop down menus to select the desired destination profiles to use for the corresponding events, then select the checkboxes for the types of notifications to send to the chosen destination profile. If

the Destination profile does not contain the required contact details, a pop-up warns you to enter the required details in the Destination profile.

9. Click the **Save** button.



Note: If you have selected the Email notification type for any of the events, you must also configure Email client settings to allow the router to send e-mail messages.

Destination configuration

The Destination configuration screen displays a list of the destination “profiles” that have been configured on the device as well as providing the option to add new profiles.

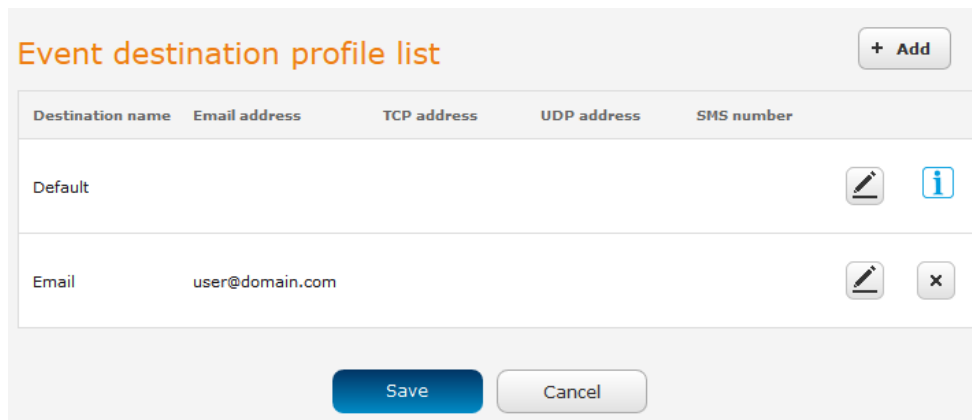

Figure 107 - Event destination list

To add a new destination profile:

1. Click the **+Add** button at the top right corner of the window. The Event destination edit screen is displayed.
2. In the **Destination name** field enter a name for the destination profile then enter the contact details for the each type of destination i.e. Email address, TCP address and port, UDP address and port and/or SMS number.
3. Click the **Save** button when you have entered the required details.

To edit a destination profile:

1. From the Event destination list, click the edit button for the corresponding destination profile. The Event destination edit page is displayed. Make the required changes.
2. Click the **Save** button.

To delete a destination profile:

1. From the Event destination list, select the delete button for the corresponding destination profile that you would like to delete. If the destination profile is linked to an event notification type, the **i** button is displayed instead of the delete button. In this case, you must go to the **Notification configuration** screen and remove the check marks from all the notification types for each event for which the destination profile is configured. When you have done that, return to the Event destination list and select the delete button.
2. Click the **Save** button.

Email settings

The Email settings screen allows the configuration of the email account that is used to send emails in features such as Event notification.

To access the Email settings page, click the **Services** menu item then select the **Email settings** menu item on the left.

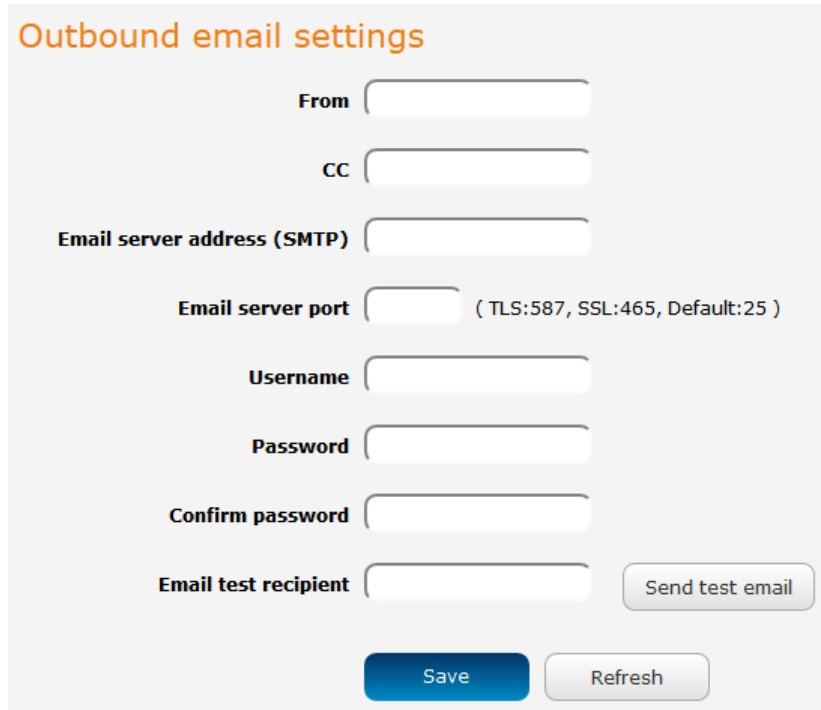

Figure 108 - Email client settings

ITEM	DESCRIPTION
From	Enter the email address of the account you will be using to send emails.
CC	(Optional) Enter an email address which will be copied on all messages sent.
Email server address (SMTP)	Enter the SMTP server address of the email server. This may be an IP address or a hostname.
Email server port	Enter the Email server's SMTP port.
Username	Enter the username of the account to be used for sending emails.
Password	Enter the password of the account to be used for sending emails.
Confirm password	Enter the password of the account to be used for sending emails once more for confirmation.
Email test recipient	Enter an email address to send a test message to, then click the Send test email button.

Table 29 - Email client settings

SMS messaging

The NTC-140W Series router offers an advanced SMS feature set, including sending messages, receiving messages, redirecting incoming messages to another destination, as well as supporting remote commands and diagnostics messages.

Some of the functions supported include:

- Ability to send a text message via a cellular network and store it in permanent storage.
- Ability to receive a text message via a cellular network and store it in permanent storage.
- Ability to forward incoming text messages via a cellular network to another remote destination which may be a TCP/UDP server or other mobile devices.
- Ability to receive run-time variables from the device (e.g. uptime) on request via SMS
- Ability to change live configuration on the device (e.g. network username) via SMS.
- Ability to execute supported commands (e.g. reboot) via SMS
- Ability to trigger the NTC-140W Series router to download and install a firmware upgrade
- Ability to trigger the NTC-140W Series router to download and apply a configuration file

To access the SMS messaging functions of the NTC-140W Series router, click on the **Services** menu item from the top menu bar, and then select one of the options under the **SMS messaging** section on the left hand menu.

Setup

The Setup page provides the options to enable or disable the SMS messaging functionality and SMS forwarding functionalities of the router. SMS messaging is enabled by default.

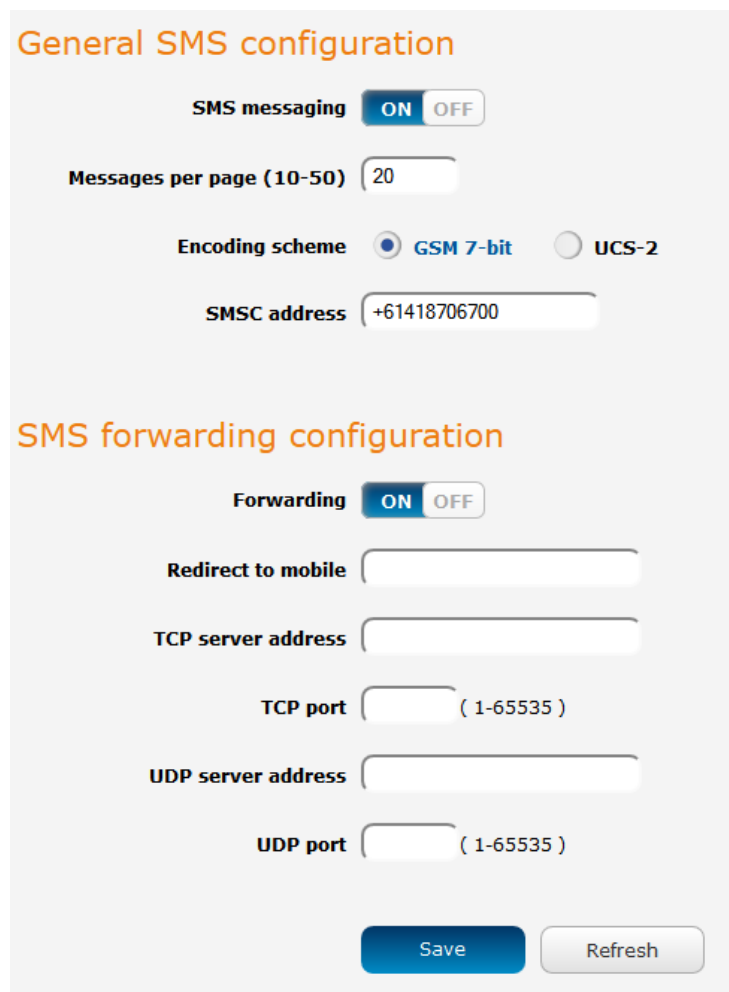

The screenshot shows two configuration sections. The first section, 'General SMS configuration', includes a toggle for 'SMS messaging' (set to ON), a 'Messages per page (10-50)' input field (set to 20), an 'Encoding scheme' with radio buttons for 'GSM 7-bit' (selected) and 'UCS-2', and an 'SMSC address' input field (set to +61418706700). The second section, 'SMS forwarding configuration', includes a toggle for 'Forwarding' (set to ON), a 'Redirect to mobile' input field, a 'TCP server address' input field, a 'TCP port' input field (with a range of 1-65535), a 'UDP server address' input field, and a 'UDP port' input field (with a range of 1-65535). At the bottom of the second section are 'Save' and 'Refresh' buttons.

Figure 109 - General SMS Configuration

OPTION	DEFINITION
General SMS configuration	
SMS messaging	Toggles the SMS functionality of the router on and off.
Messages per page (10-50)	The number of SMS messages to display per page. Must be a value between 10 and 50.
Encoding scheme	The encoding method used for outbound SMS messages. GSM 7-bit mode permits up to 160 characters per message but drops to 50 characters if the message includes special characters. UCS-2 mode allows the sending of Unicode characters and permits a message to be up to 50 characters in length.
SMS forwarding configuration	
Forwarding	Toggles the SMS forwarding function of the router on and off.
Redirect to mobile	Enter a mobile number as the destination for forwarded SMS messages.
TCP server address	Enter an IP address or domain name as the destination for forwarded SMS messages using TCP.
TCP port	The TCP port on which to connect to the remote destination.
UDP server address	Enter an IP address or domain name as the destination for forwarded SMS messages using UDP.
UDP port	The UDP port on which to connect to the remote destination.

Table 30 - SMS Setup Settings

SMS forwarding configuration

Incoming text messages can be redirected to another mobile device and/or a TCP/UDP message server.

Redirect to mobile

You can forward incoming text messages to a different destination number. This destination number can be another mobile phone or a router phone number.

For Example:

If someone sends a text message and **Redirect to mobile** is set to "+61412345678", the text message is stored on the router and forwarded to "+61412345678" at the same time.

To disable redirection to a mobile, clear the **Redirect to mobile** field and click the **Save** button.

Redirect to TCP / UDP server address

You can also forward incoming text messages to a TCP/UDP based destination. The TCP or UDP server can be any kind of public or private server if the server accepts incoming text-based messages.

The TCP/UDP address can be an IP address or domain name. The port number range is from 1 to 65535. Please refer to your TCP/UDP based SMS server configuration for which port to use.

For Example:

If someone sends a text message and **TCP server address** is set to "192.168.20.3" and **TCP port** is set to "2002", this text message is stored in the router and forwarded to "192.168.20.3" on port "2002" at the same time.

To disable redirection to a TCP or UDP address, clear the **TCP server address** and **UDP server address** fields and click the **Save** button.

New message

The New message page can be used to send SMS text messages to a single or multiple recipients. To access the New message page, click on the **Services** menu item from the top menu bar, select the **SMS messaging** menu on the left then select the **New message** menu item.

A new SMS message can be sent to a maximum of 9 recipients at the same time. After sending the message, the result is displayed next to the destination number as “**Success**” or “**Failure**” if the message failed to send. By default, only one destination number field is displayed. Additional destination numbers may be added one at a time after entering a valid number for the current destination number field. To add a destination number, click the **+** button and to remove the last destination in the list, click the **-** button.

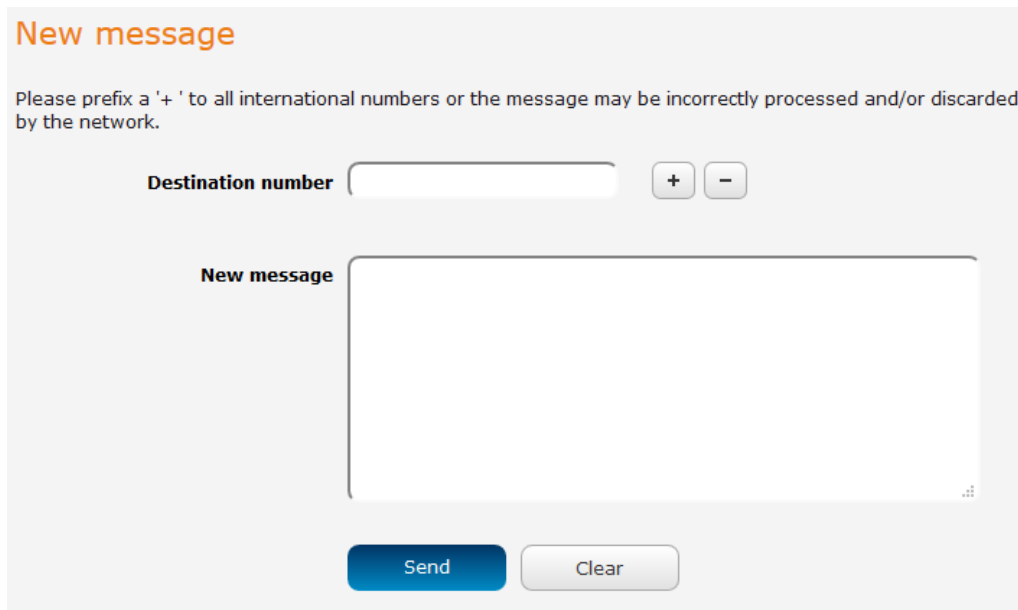

Figure 110 - SMS - New Message

Destination numbers should begin with the “+” symbol followed by the country calling code. To send a message to a destination number, enter the “+” symbol followed by the country calling code and then the destination number.

For example:

To send a message to the mobile destination number 0412345678 in Australia (country calling code 61), enter “+61412345678”.

After entering the required recipient numbers, type your SMS message in the **New message** field. As you type your message, a counter shows how many characters you have entered out of the total number available for your chosen encoding scheme. When you have finished typing your message and you are ready to send it, click the **Send** button.

Inbox / Sent Items

The Inbox displays all received messages that are stored on the router while Sent Items displays all sent messages. To access the Inbox page, click on the **Services** menu item from the top menu bar, select the **SMS messaging** menu on the left then select the **Inbox** menu item.

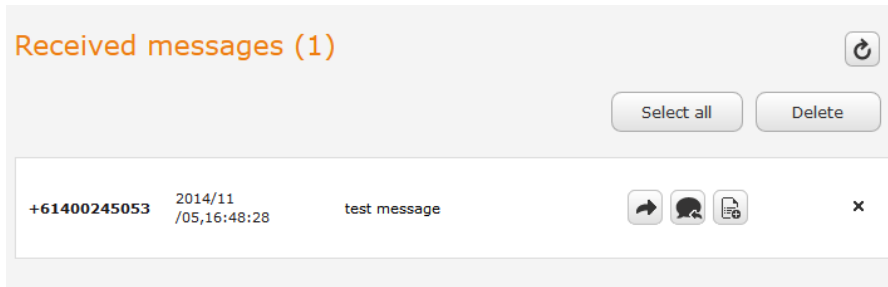

Figure 111 - SMS Inbox

To access the Sent items page, click on the **Services** menu item from the top menu bar, select the **SMS messaging** menu on the left then select the **Sent items** menu item.

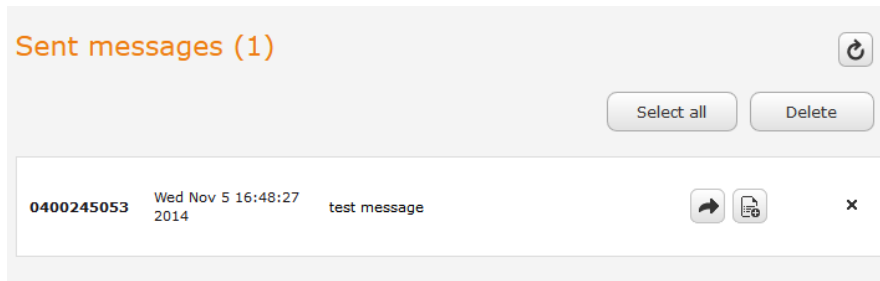

Figure 112 - SMS Outbox





ICON	DESCRIPTION
	Forward button. Click this button to open a new message window where you can forward the corresponding message to another recipient.
	Reply button. Click this button to open a new message window where you can reply to the sender.
	Add to White list. Click this button to add the sender's mobile number to the white list on the router.
	Delete button. Click this button to delete the corresponding message.
	Refresh button. Click this button to refresh the inbox or outbox to see new messages.

Table 31 - Inbox/Outbox icons

Diagnostics

The Diagnostics page is used to configure the SMS diagnostics and command execution configuration. This allows you to change the configuration, perform functions remotely and check on the status of the router via SMS commands.

To access the Diagnostics page, click on the **Services** menu item then select the **SMS** menu on the left and finally select **Diagnostics** beneath it.

SMS diagnostics and command execution configuration

Enable remote diagnostics and command execution ON OFF

Only accept authenticated SMS messages ON OFF

Send Set command acknowledgement replies ON OFF

Access advanced RDB variables ON OFF

Allow execution of advanced commands ON OFF

Send acknowledgement replies to a fixed number the sender's number

Send command error replies ON OFF

Send error replies to a fixed number the sender's number

Send a maximum number of replies per
0 / 100 messages sent

Limit the number of diagnostic text messages that can be sent in a designated time period. Currently, the 'messages sent' count automatically resets at the end of the designated time period. For example, it will reset to zero at 01:00, 02:00, 03:00 etc for 'hour', 00:00 for 'day', 00:00 on Monday for 'week' and the first day of the month for 'month', or at anytime the unit reboots.

White list for diagnostic or execution SMS

All incoming diagnostic or execution text messages are checked against this white list. If the message sender and password don't match any destination numbers and passwords in this white list, the message is ignored and an error message reply is sent to the sender or to a predefined destination. You can add up to 20 destination numbers via the SMS inbox/sent items pages by clicking on 'Add white list'. Alternatively, click on 'Add' below to add a number now.

The white list is empty

Figure 113 - SMS diagnostics and command execution configuration

SMS diagnostics and command execution configuration

The options on this page are described below.

Enable remote diagnostics and command execution

Enables or disables the remote diagnostics feature. If this setting is enabled all incoming text messages are parsed and tested for remote diagnostics commands.

If remote diagnostics commands are found, the router executes those commands. This feature is enabled by default. All remote diagnostic commands that are received are stored in the Inbox.



Note: It is possible to adjust settings and prevent your router from functioning correctly using remote diagnostics. If this occurs, you will need to perform a factory reset in order to restore normal operation.



We highly recommended that you use the white list and a password when utilising this feature to prevent unauthorised access. See the [White list](#) description for more information.

Only accept authenticated SMS messages

Enables or disables checking the sender's phone number against the allowed sender white list for incoming diagnostics and command execution SMS messages.

If authentication is enabled, the router will check if the sender's number exists in the white list. If it exists, the router then checks the password (if configured) in the incoming message against the password in the white list for the corresponding sending number. If they match, the diagnostic or command is executed.

If the number does not exist in the white list or the password does not match, the router does not execute the incoming diagnostic or command in the SMS message.

This is enabled by default and it is strongly advised that you leave this feature enabled to maintain security.

Send Set command acknowledgement replies

The NTC-140W Series router will automatically reply to certain types of commands received, such as *get* commands, or *execute* commands. However acknowledgement replies from the NTC-140W Series router are optional with *set* commands and the *Wakeup* command. This option Enables or disables sending an acknowledgment message after execution of a *set* command or SMS Wakeup command. If disabled, the router does not send any acknowledgement after execution of a *set* command or SMS Wakeup command. All acknowledgment replies are stored in the Outbox after they have been sent. This can be useful to determine if a command was received and executed by the router. This option is disabled by default.

Access advanced RDB variables

By default, this option is turned off and only allows access to the [basic RDB variables](#) listed later in this guide. If this option is enabled, you are able to access the full list of RDB variables via SMS.

Allow execution of advanced commands

By default, this option is turned off and only allows execution of the [basic commands](#) listed later in this guide. If this option is enabled, you are able to execute advanced commands such as those which are common to the Linux command line. For example: "execute ls /usr/bin/sms*" to list the contents of the /etc folder on the router.

Send acknowledgement replies to

This option allows you to specify where to send acknowledgment messages after the execution of a *set*, *get*, or *exec* command.

If a **fixed number** is selected, the acknowledgement message will be sent to the number defined in the **Fixed number to send replies** to field. If **the sender's number** is selected, the acknowledgement message will be sent to the number that the SMS diagnostic or command message originated from. The default setting is to use **the sender's number**.

Fixed number to send replies to

This field defines the destination number to which error messages are sent after the execution of a *get*, *set*, or *exec* command. This field is only displayed when **Send Error SMS to** is set to **Fixed Number**.

Send command error replies

Enables or disables the sending of an error message resulting from the execution of a *get*, *set*, or *exec* command. All error replies are stored in the Outbox after they have been sent.

Send error replies to

When **Send Error SMS for Get/Set/Exec Command** is set to **ON**, this option is used to specify where the error SMS is sent. Use the radio buttons to select either **Fixed Number** or **SMS Sender Number**. When set to **SMS Sender Number** the router will reply to the originating number of the SMS diagnostic or command. When set to **Fixed Number** the router will send the error messages to the number specified in the following field.

Send a maximum number of

You can set the maximum number of acknowledgement and error messages sent when an SMS diagnostic or command is executed. The maximum limit can be set per hour, day, week or month. The router will send a maximum of 100 replies by default.

The number of messages sent is shown below the options. The total transmitted message count resets after a reboot or at the beginning of the time frame specified.

White List for diagnostic or execution SMS

The white list is a list of mobile numbers that you can create which are considered “friendly” to the router. If **Only accept authenticated SMS messages** is enabled in the diagnostics section, the router will compare the mobile number of all incoming diagnostic and command messages against this white list to determine whether the diagnostic or command should be executed. You may optionally configure a password for each number to give an additional level of security. When a password is specified for a number, the SMS diagnostic or command message is parsed for the password and will only be executed if the number and password match.

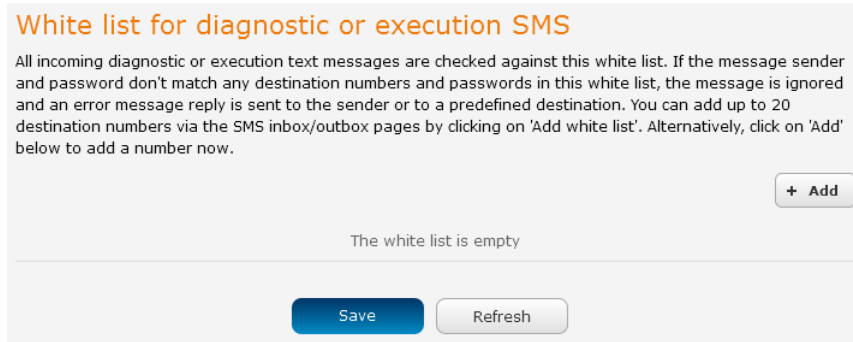

White list for diagnostic or execution SMS

All incoming diagnostic or execution text messages are checked against this white list. If the message sender and password don't match any destination numbers and passwords in this white list, the message is ignored and an error message reply is sent to the sender or to a predefined destination. You can add up to 20 destination numbers via the SMS inbox/outbox pages by clicking on 'Add white list'. Alternatively, click on 'Add' below to add a number now.

+ Add

The white list is empty

Save Refresh

Figure 114 - White list for diagnostic or execution SMS

A maximum of 20 numbers can be stored on the router in the white list. To add a number to the white list, click the “+Add” button.

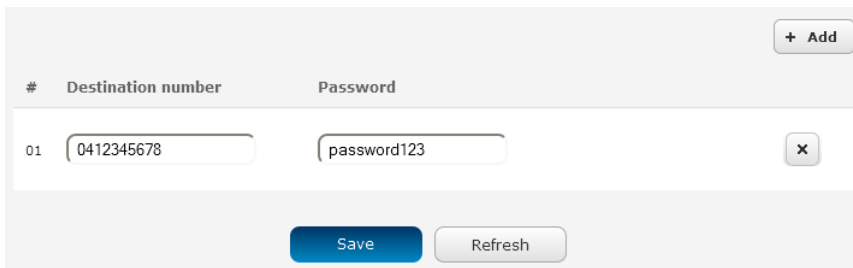

+ Add

#	Destination number	Password
01	0412345678	password123

x

Save Refresh

Figure 115 – Adding a number to the SMS white list

The White List numbers and passwords can be cleared by pressing the  button to the right of each entry. To add a number to the white list, enter it in the **Destination number** field and optionally define a password in the **Password** field. When you have finished adding numbers click the **Save** button to save the entries.

Sending an SMS Diagnostic Command

Follow the steps below to configure the router to optionally accept SMS diagnostic commands only from authenticated senders and learn how to send SMS diagnostic commands to the router.

1. Navigate to the **Services > SMS messaging > Diagnostics** page
2. Confirm that the **Enable remote diagnostics and command execution** toggle key is set to the **ON** position. If it is set to **OFF** click the toggle key to switch it to the **ON** position.
3. If you wish to have the router only accept commands from authenticated senders, ensure that **Only accept authenticated SMS messages** is set to the **ON** position. In the **White list for diagnostic or execution SMS messages** section, click the **+Add** button and enter the sender's number in international format into the **Destination number** field that appears. If you wish to also configure a password, enter the password in the **Password** field corresponding to the destination number.
4. If you would prefer to accept SMS diagnostic commands from any sender, set the **Only accept authenticated SMS messages** toggle key to the **OFF** position.





Note: An alternative method of adding a number to the white list is to send an SMS message to the router, navigate to **Services > SMS messaging > Inbox** and then click the  button next to the message which corresponds to the sender's number.



5. Click the **Save** button.

Types of SMS diagnostic commands



There are three types of commands that can be sent; **execute**, **get** and **set**. The basic syntax is as follows:

-  execute COMMAND
-  get VARIABLE
-  set VARIABLE=VALUE

If authentication is enabled, each command must be preceded by the password:

-  PASSWORD execute COMMAND
-  PASSWORD get VARIABLE
-  PASSWORD set VARIABLE=VALUE

The following are some examples of SMS diagnostic commands:

-  password6657 execute reboot
-  get rssi
-  set apn1=testAPNvalue

SMS acknowledgment replies

The router automatically replies to **get** commands with a value and **execute** commands with either a success or error response. **Set** commands will only be responded to if the **Send Set command acknowledgement replies** toggle key is set to **ON**. If the **Send command error replies** toggle key is set to **ON**, the router will send a reply if the command is correct but a variable or value is incorrect, for example, due to misspelling.

SMS command format

Generic Format for reading variables:

get VARIABLE

PASSWORD get VARIABLE

Generic Format for writing to variables:

set VARIABLE=VALUE

PASSWORD set VARIABLE=VALUE

Generic Format for executing a command:

Execute COMMAND

PASSWORD execute COMMAND

Replies

Upon receipt of a successfully formatted, authenticated (if required) command, the gateway will reply to the SMS in the following format:

TYPE	SMS CONTENTS	NOTES
get command	"VARIABLE=VALUE"	
set command	"Successfully set VARIABLE to VALUE"	Only sent if the acknowledgment message function is enabled
execute command	"Successfully executed command COMMAND"	

Table 32 - SMS Diagnostic Command Syntax

Where "VARIABLE" is the name of the value to be read

Where "VARIABLE (x)" is the name of another value to be read

Where "VALUE" is the content to be written to the "VARIABLE"

Where "COMMAND" is a supported command to be executed by the device (e.g. reboot)

Where "PASSWORD" is the password (if configured) for the corresponding sender number specified in the White List

Multiple commands can be sent in the same message, if separated by a semicolon.

For Example:

get VARIABLE1; get VARIABLE2; get VARIABLE3

PASSWORD get VARIABLE1; get VARIABLE2

set VARIABLE=VALUE1 ; set VARIABLE2=VALUE2

PASSWORD set VARIABLE1=VALUE1; set VARIABLE2=VALUE2; set VARIABLE3=VALUE3

If required, values can also be bound by an apostrophe, double apostrophe or back tick.

For Example:

"set VARIABLE='VALUE'"

"set VARIABLE='\"VALUE\"'"

"set VARIABLE=`VALUE`"

"get VARIABLE"

A password (if required), only needs to be specified once per SMS, but can be prefixed to each command if desired.

“PASSWORD get Variable1”; “get VARIABLE2”

“PASSWORD set VARIABLE1=VALUE1”; “set VARIABLE2=VALUE2”

If the command sent includes the “reboot” command and has already passed the white list password check, the device keeps this password and executes the remaining command line after the reboot with this same password.

For Example:

“PASSWORD execute reboot; getVariable1”; “get VARIABLE2”

“PASSWORD execute reboot; PASSWORD get Variable1”; “get VARIABLE2”



Note: Commands, variables and values are case sensitive.

List of basic commands

A list of basic commands which can be used in conjunction with the execute command are listed below:

“pdpcycle”, “pdpdown” and “pdpup” commands can have a profile number suffix ‘x’ added. Without the suffix specified, the command operates against the default profile configured on the profile list page of the Web-UI.

#	COMMAND NAME	DESCRIPTION
1	reboot	Immediately performs a soft reboot.
2	pdpcycle	Disconnects (if connected) and reconnects the data connection. If a profile number is selected in the command, try to disconnect/reconnect the specified profile in case the profile is active. If no profile number is selected, try to disconnect/reconnect the current active profile. Reports an error if no profile number is selected and there is no currently activated profile.
3	pdpdown	Disconnects the PDP. If a profile number is selected in the command, the router tries to disconnect the specified profile in case the profile is active. If no profile number is selected, try to disconnect the current active profile. Reports an error if no profile number is selected and there is no currently activated profile.
4	pdpup	Reconnects the PDP. If a profile number is selected in the command, the router tries to connect with the specified profile. If no profile number is selected, the router tries to connect to the last active profile. The gateway will check the currently activated profile and disconnect this profile before executing the command. The router reports an error if no profile number is selected and there is no stored last active profile number.
5	factorydefaults	Performs a factory reset on the router. Be aware that this command also clears the SMS white list on the router.
6	download	Performs a download and install of a Firmware Upgrade (.cdi), Config File (.tar.gz) or a help document (.pdf) file. If the file is a firmware image as in the case of a .cdi file, the router will apply the recovery image first and then the main firmware image. The download location is specified immediately after the command and may be from an HTTP or FTP source URL. If the file is a .cdi file, the router will apply the file as a configuration file update for the device and reboot afterwards. If the file is a .pdf, the router will assume this is a user guide document and save it to the router and make the file available for viewing via the help menu on the Web-UI. Note: If your download URL includes any space characters, please encode these prior to transmission according to RFC1738, for example: <code>ftp://username:password@serveraddress/directory%20with%20spaces/filename.cdi</code> Note: Authenticated FTP addresses may be used following the format as defined in RFC1738, for example: ftp://username:password@serveraddress/directory/filename.cdi
7	codconnect	Causes the router to activate the PDP context when the Connect on demand feature is enabled.
8	coddisconnect	Causes the router to de-activate the PDP context when the Connect on demand feature is enabled.
9	wakeup	This forces the default Data connection profile to connect if it is in a disconnected or waiting state. There are two circumstances in which this command may be useful; where the default profile is enabled but has been manually disconnected and if Connect on demand is enabled and the router is awaiting packet of interest. In both of these situations, the wakeup command will cause the default PDP context to activate.
10	ssh.genkeys	Instructs the router to generate new public SSH keys.
11	ssh.clearkeys	Instructs the router to clear the client public SSH key files.

Table 33 - List of basic SMS diagnostic commands

List of get/set commands

The following table is a partial list of get and set commands which may be performed via SMS.

COMMAND NAME	EXAMPLE	DESCRIPTION
get status	get status	Returns the Module firmware version, LAN IP Address, Network State, Network operator and RSSI.
get sessionhistory	get sessionhistory	Returns the time and date of recent sessions along with the total amount of data sent and received for each session.
set syslogserver	set syslogserver=123.45.67.89:514	Sets a remote syslog server IP or hostname and port.
set cod	set cod=1	Enables or disables Connect on demand.
get cod	get cod	Returns the enable/disable status of the Connect on demand feature.
get codstatus	get codstatus	Returns the connection status of the Connect on demand feature.
set coddialport	set coddialport=on,53	Sets the Connect on demand feature to connect only when traffic is received on the specified port.
get coddialport	get coddialport	Returns the Connect on demand port filter status and list of filtered ports.
set codonline	set codonline=20	Sets the router to stay online for at least X minutes when data activity is detected.
get codonline	get codonline	Returns the number of minutes the router is configured to stay online when data activity is detected.
set codminonline	set codminonline=10	Sets the router to stay online for a minimum of X minutes after connecting.
get codminonline	get codminonline	Returns the minimum number of minutes the router should stay online after connecting.
set codredial	set codredial=5	Sets the number of minutes that the router should not attempt to redial after hanging up.
get codredial	get codredial	Returns the number of minutes that the router is configured to not attempt to redial after hanging up.
set coddisconnect	set coddisconnect=0	Sets the number of minutes after which the router should disconnect regardless of traffic.
get coddisconnect	get coddisconnect	Returns the number of minutes the router is configured to disconnect regardless of traffic.
set codconnectreg	set codconnectreg=30	Sets the number of minutes that the router should regularly attempt to connect.
get codconnectreg	get codconnectreg	Returns the number of minutes that the router is configured to regularly attempt to connect.
set codrandomtime	set codrandomtime=3	Sets the number of minutes that the router should randomise the dial time by.
get codrandomtime	get codrandomtime	Returns the number of minutes that the router is configured to randomise the dial time by.
set codverbose	set codverbose=1	Sets verbose logging on or off.
get codverbose	get codverbose	Returns the status of verbose logging.
set codignore.icmp	set codignore.icmp=1	Sets the router to ignore ICMP packets triggering data activity detection.
get codignore.icmp	get codignore.icmp	Returns the status of the Ignore ICMP option.
set codignore.tcp	set codignore.tcp=1	Sets the router to ignore TCP packets triggering data activity detection.
get codignore.tcp	get codignore.tcp	Returns the status of the Ignore TCP option.
set codignore.udp	set codignore.udp=1	Sets the router to ignore UDP packets triggering data activity detection.
get codignore.udp	get codignore.udp	Returns the status of the Ignore UDP option.
set codignore.dns	set codignore.dns=1	Sets the router to ignore DNS traffic triggering data activity detection.
get codignore.dns	get codignore.dns	Returns the status of the Ignore DNS option.
set codignore.ntp	set codignore.ntp=1	Sets the router to ignore NTP traffic triggering data activity detection.
get codignore.ntp	get codignore.ntp	Returns the status of the Ignore NTP option.
set codignore.ncsi	set codignore.ncsi=1	Sets the router to ignore NCSI traffic triggering data activity detection.
get codignore.ncsi	get codignore.ncsi	Returns the status of the Ignore NCSI option.
get plmnscan	get plmnscan	Instructs the router to perform a network scan and returns the results by SMS.
set forceplmn	set forceplmn=505,3	Sets the operator to a manual selection made by the user where "505" is the Mobile Country Code for Australia and "3" is the Mobile Network Code for Vodafone. As no network type (e.g.. LTE/3G/2G) is specified, it is selected automatically.
get forceplmn	get forceplmn	Returns the operator and network type selection mode (Automatic/Manual), in addition to the MCC and MNC values
get pppoe	get pppoe	Returns the PPPoE status, currently configured dial string and service name
set pppoe	set pppoe=1, telstra.internet, test	Sets the PPPoE status on, APN to telstra.internet, and service name to test.

get ledmode	get ledmode	Returns the status of the LED operation mode.
set ledmode	set ledmode=10	Sets the LED operation mode to be always on or to turn off after the specified number of minutes.
get ssh.proto	get ssh.proto	Returns the SSH protocol in use.
set ssh.proto	set ssh.proto=1,2	Sets the SSH Protocol to protocol 1, 2 or both (1,2).
get ssh.passauth	get ssh.passauth	Returns the status of the SSH Enable password authentication option.
set ssh.passauth	set ssh.passauth=1	Sets the SSH Enable password authentication option on or off.
get.ssh.keyauth	get.ssh.keyauth	Returns the status of the SSH Enable key authentication option.
set.ssh.keyauth	set.ssh.keyauth=1	Sets the SSH Enable key authentication option on or off.
get download.timeout	get download.timeout	Returns the time in minutes that the router waits before a download times out.
set download.timeout	set download.timeout=20	Sets the time in minutes that the router waits before a download times out. This is set to 10 minutes by default. Supported range is 10 – 1440 minutes.
get install.timeout	get install.timeout	Returns the time in minutes that the router waits before a file that is being installed times out.
set install.timeout	set install.timeout=5	Sets the time in minutes that the router waits before a file that is being installed times out. This is set to 3 minutes by default. Supported range is 3 – 300 minutes.

Table 34 - List of get/set commands

List of basic RDB variables

The following table lists valid variables where “x” is a profile number (1-6). If no profile is specified, variables are read from or written to for the current active profile. If a profile is specified, variables are read from or written to for the specified profile number ('x').

#	RDB VARIABLE NAME	SMS VARIABLE NAME	READ/ WRITE	DESCRIPTION	EXAMPLE VALUE
0	link.profile.1.enable link.profile.1.apn link.profile.1.user link.profile.1.pass link.profile.1.auth_type link.profile.1.iplocal link.profile.1.status	profile	RW	Profile	Read: (profile no,apn,user,pass,auth,iplocal,status) 1,apn,username,password, chap,202.44.185.111,up Write: (apn, user, pass,auth) apn,username,password
2	link.profile.1.user	username	RW	Cellular broadband username	Guest, could also return “null”
3	link.profile.1.pass	password	RW	Cellular broadband password	Guest, could also return “null”
4	link.profile.1.auth_type	authtype	RW	Cellular broadband Authentication type	“pap” or “chap”
5	link.profile.1.iplocal	wanip	R	WAN IP address	202.44.185.111
6	wwan.0.radio.information.signal_strength	rssi	R	Cellular signal strength	-65 dBm
7	wwan.0.imei	imei	R	IMEI number	357347050000177
8	statistics.usage_current	usage	R	Cellular broadband data usage of current session	“Rx 500 bytes, Tx 1024 bytes, Total 1524 bytes” or “Rx 0 byte, Tx 0 byte, Total 0 byte” when wwan down
9	statistics.usage_current	wanuptime	R	Up time of current cellular broadband session	1 days 02:30:12 or 0 days 00:00:00 when wwan down
10	/proc/uptime	deviceuptime	R	Device up time	1 days 02:30:12
11	wwan.0.system_network_status.current_band	band	R	Current band	WCDMA850





Table 35 - List of basic SMS diagnostics RDB variables

Network scan and manual network selection by SMS

Performing a network scan

The **get plmnscan** SMS command enables you to perform a scan of the cellular networks available at the time of the scan.

It returns the following semi-colon separated information for each network in range:

-  MCC
-  MNC
-  Network Type (LTE, 3G, 2G)
-  Provider's Name
-  Operator Status (available, forbidden, current)

The following is an example of a response from the **get plmnscan** SMS command:

```
plmnscan:505,3,7,vodafone AU,4;505,3,1,vodafone AU,1;505,2,7,YES OPTUS,1;505,2,1,YES OPTUS,1;505,1,1,Telstra Mobile,1;505,1,7,Telstra Mobile,1
```

NETWORK TYPE	DESCRIPTION
9	Indicates an LTE network.
7	Indicates a 3G network
1	Indicates a 2G network

Table 36 - Network types returned by get plmnscan SMS command

OPERATOR STATUS	DESCRIPTION
1	Indicates an available operator which may be selected.
2	Indicates a forbidden operator which may not be selected (applies only to generic SIM cards).
4	Indicates the currently selected operator.

Table 37 - Operator status codes returned by get plmnscan SMS command



Notes about the network connection status when using the **get plmnscan** command:

- If the connection status is **Up** and connection mode is **Always on**, the **get plmnscan** SMS will cause the connection to disconnect, perform the scan, send the result through SMS and then bring the connection back up again. If the connection status is **Down**, the router will perform the PLMN scan, send the result and keep the connection status down.
- If the connection status is **Waiting** and connection mode is **Connect on demand**, the **get plmnscan** SMS will change the connection status to **Down**, perform the scan, send the result through SMS and then restore the connection status to the **Waiting** state.
- If the connection status is **Up** and connection mode is **Connect on demand**, the **get plmnscan** SMS will cause the connection to disconnect, perform the scan, send the result through SMS, and then restore the connection status to the **Waiting** state unless there is a traffic which triggers a connection in which case the connection status will be set to **Up**.

Setting the router to connect to a network

The router can be instructed by SMS to connect to one of the networks returned by the **get plmnscan** command. The **set forceplmn** command forces the router to connect to a specified operator network (if available) while the **get forceplmn** command retrieves the currently configured network on the router.

Command format:

```
set forceplmn=0|MCC,MNC| MCC,MNC,Network Type
```

For example:

```
set forceplmn=0
```

Sets the selection of operator and network type to automatic mode.

```
set forceplmn=505,3
```

Sets the operator to a manual selection made by the user where “505” is the Mobile Country Code for Australia and “3” is the Mobile Network Code for Vodafone. As no network type (e.g. LTE/3G/2G) is specified, it is selected automatically.

```
set forceplmn=505,3,7
```

Sets the operator and network type to a manual selection made by the user where “505” is the Mobile Country Code for Australia, “3” is the Mobile Network Code for Vodafone and “7” is the 3G network type.



Notes about the **set forceplmn** command:

1. If the manual selection fails, the device will fall back to the previous ‘good’ network.
2. When enabled, the SMS acknowledgement reply reflects the success or failure of the manual selection with respect to the *set* command and includes the final MNC/MCC that was configured.

Confirming the currently configured operator and network type

You can retrieve the currently configured operator and network type using the **get forceplmn** command.

The **get forceplmn** command returns the operator and network type selection mode (Automatic/Manual), in addition to the MCC and MNC values, for example:

```
Automatic,505,3
```

This response indicates that the operator/network selection mode is Automatic, and the network used is Vodafone AU.

SMS diagnostics examples

The examples below demonstrate various combinations of supported commands. This is not an exhaustive list and serves as an example of possibilities only.

DESCRIPTION	AUTHENTICATION	INPUT EXAMPLE
Send SMS to change the data connection username	Not required	set username='NetComm'
	Required	PASSWORD set username= "NetComm"
Send SMS to change the data connection password	Not required	set password= 'NetComm'
	Required	PASSWORD set password= 'NetComm'
Send SMS to change the data connection authentication	Not required	set authtype= 'pap'
	Required	PASSWORD set authtype = pap
Send SMS to reboot	Not required	execute reboot
	Required	PASSWORD execute reboot
Send SMS to check the WAN IP address	Not required	get wanip
	Required	PASSWORD get wanip
Send SMS to check the mobile signal strength	Not required	get rssi
	Required	PASSWORD get rssi
Send SMS to check the IMEI number	Not required	get imei
	Required	PASSWORD get imei
Send SMS to check the current band	Not required	get band
	Required	PASSWORD get band
Send SMS to Disconnect (if connected) and reconnect the data connection	Not required	execute pdpcycle
	Required	PASSWORD execute pdpcycle
Send SMS to disconnect the data connection	Not required	execute pdpdown
	Required	PASSWORD execute pdpdown
	Not required	execute pdpup

Send SMS to connect the data connection	Required	PASSWORD execute pdpup
Send multiple get command	Not required	get wanip; get rssi
	Required	PASSWORD get wanip; get rssi
Send multiple set command	Not required	set ssh.genkeys=1; set username=test; set auth=pap
	Required	PASSWORD set ssh.genkeys=1; set username=test; set auth=pap
Send SMS to reset to factory default settings	Not required	execute factorydefaults
	Required	PASSWORD execute factorydefaults
Send SMS to retrieve status of router	Not required	get status
	Required	PASSWORD get status
Send SMS to retrieve the history of the session, including start time, end time and total data usage	Not required	get sessionhistory
	Required	PASSWORD get sessionhistory
Send SMS to configure the router to send syslog to a remote syslog server	Not required	set syslogserver=123.209.56.78
	Required	PASSWORD set syslogserver=123.209.56.78
Send SMS to wake up the router, turn on the default gateway and trigger the 'connect on demand' profile if in waiting state.	Not required	execute wakeup
	Required	PASSWORD execute wakeup
Send SMS to perform firmware upgrade when firmware is located on HTTP server	Not required	execute download http://download.com:8080/firmware_image.cdi execute download http://download.com:8080/firmware_image_r.cdi
	Required	PASSWORD execute download http://download.com:8080/firmware_image.cdi PASSWORD execute download http://download.com:8080/firmware_image_r.cdi
Send SMS to perform firmware upgrade when firmware is located on FTP server	Not required	execute download ftp://username:password@download.com/firmware_image.cdi execute download ftp://username:password@download.com/firmware_image_r.cdi
	Required	PASSWORD execute download ftp://username:password@download.com/firmware_image.cdi PASSWORD execute download ftp://username:password@download.com/firmware_image_r.cdi
Send SMS to download and install IPK package located on HTTP server	Not required	execute download http://download.com:8080/package.ipk
	Required	PASSWORD execute download http://download.com:8080/package.ipk
Send SMS to download and install IPK package located on FTP server	Not required	execute download ftp://username:password@download.com:8080/package.ipk
	Required	PASSWORD execute download ftp://username:password@download.com:8080/package.ipk
Send SMS to turn off PPPoE	Not required	set pppoe=0
	Required	PASSWORD set pppoe=0
Send SMS to retrieve the PPPoE status, currently configured dial string and service name	Not required	get pppoe
	Required	PASSWORD get pppoe
Send SMS to set the LED mode timeout to 10 minutes	Not required	set ledmode=10
	Required	PASSWORD set ledmode=10
Send SMS to retrieve the current LED mode	Not required	get ledmode
	Required	PASSWORD get ledmode
Retrieve current SSH protocol	Not required	get ssh.proto
	Required	PASSWORD get ssh.proto
Select SSH protocol	Not required	set ssh.proto=1
	Required	PASSWORD set ssh.proto=1
Retrieve password authentication status	Not required	get ssh.passauth
	Required	PASSWORD get ssh.passauth
Enable/disable password authentication on host	Not required	set ssh.passauth=1 or set ssh.passauth=0
	Required	PASSWORD set ssh.passauth=1 or PASSWORD set ssh.passauth=0

Generate set of public/private keys on the host	Not required	execute ssh.genkeys
	Required	PASSWORD execute ssh.genkeys
Clear client public keys stored on host	Not required	execute ssh.clearkeys
	Required	PASSWORD execute ssh.clearkeys

Table 38 - SMS diagnostics example commands

System

Log

The Log pages are used to display or download the System log and IPSec logs on the router.

System log

The System Log enables you to troubleshoot any issues you may be experiencing with your NTC-140W Series router. To access the System Log page, click on the **System** menu. The System Log is displayed.

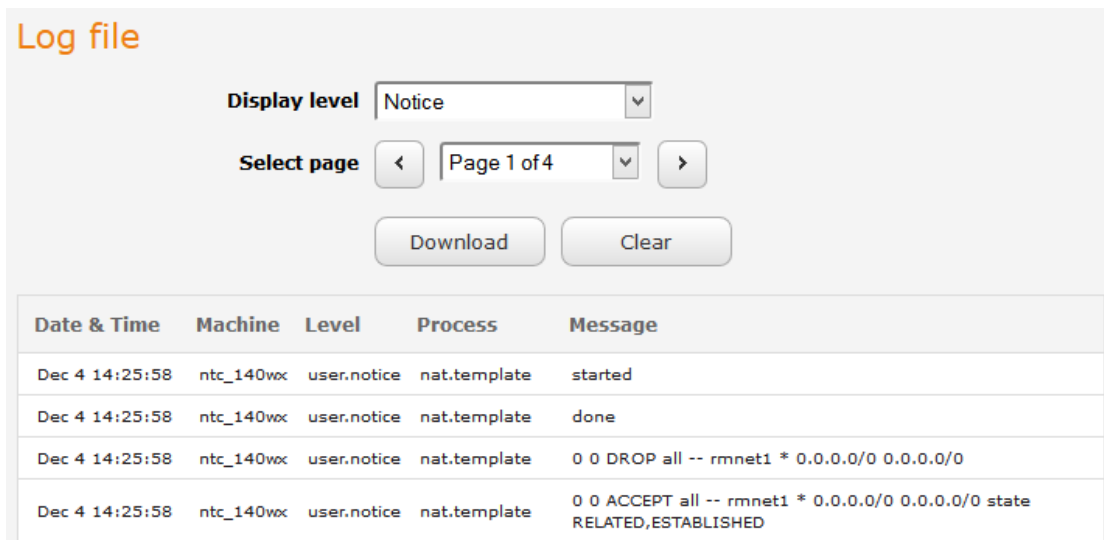

Log file

Display level: Notice

Select page: Page 1 of 4

Download Clear

Date & Time	Machine	Level	Process	Message
Dec 4 14:25:58	ntc_140wx	user.notice	nat.template	started
Dec 4 14:25:58	ntc_140wx	user.notice	nat.template	done
Dec 4 14:25:58	ntc_140wx	user.notice	nat.template	0 0 DROP all -- rmnet1 * 0.0.0.0/0 0.0.0.0/0
Dec 4 14:25:58	ntc_140wx	user.notice	nat.template	0 0 ACCEPT all -- rmnet1 * 0.0.0.0/0 0.0.0.0/0 state RELATED,ESTABLISHED

Figure 116 - System log file

Log file

Use the **Display level** drop-down list to select a message level to be displayed. The message levels are described in the table below.

To download the System log for offline viewing, right-click the **Download** button and choose **Save as..** to save the file. To clear the System log, click the **Clear** button. The downloaded log file is in Linux text format with carriage return (CR) only at the end of a line, therefore in order to be displayed correctly with new lines shown, it is recommended to use a text file viewer which displays this format correctly (e.g. Notepad++).

IPSec log

The IPSec log section provides the ability for you to download the log for the IPSec VPN function. This can assist in troubleshooting any problems you may have with the IPSec VPN. To access the IPSec log page, click on the **System** menu item then select the **Log** menu on the left and finally select **IPSec log** beneath it.

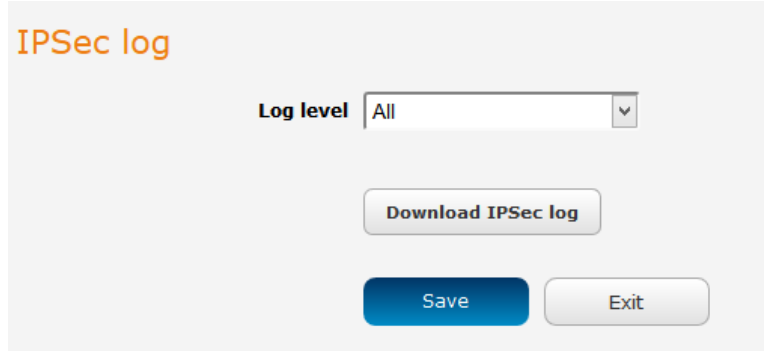

Figure 117 - IPSec log

Use the **Log level** drop down list to specify the type of detail you want to capture in the log and then click the **Save** button. When you change the logging level, any active IPSec VPN tunnels will be disconnected as a change in logging level requires the IPSec service to be restarted.

To download the IPSec log, click the **Download IPSec log** button and you will be prompted to save the file.

Event notification log

The Event notification log section provides the ability for you to download the log for the Event notification function. This can assist in troubleshooting any problems you may have with the Event notification feature. To access the Event notification log page, click on the **System** menu item then select the **Log** menu on the left and finally select **Event notification log** beneath it.

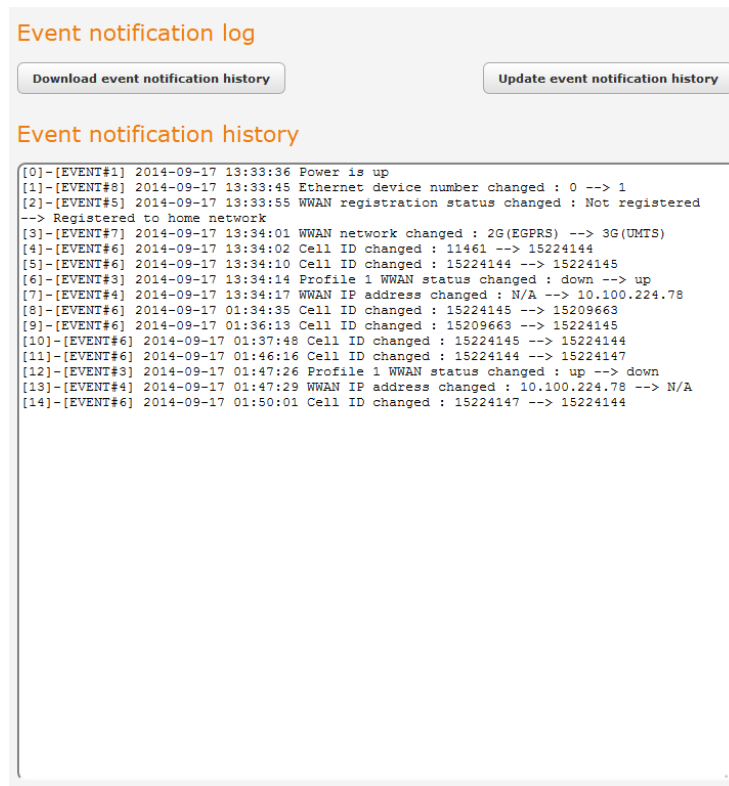

Event notification log

[Download event notification history](#) [Update event notification history](#)

Event notification history

```
[0]-[EVENT#1] 2014-09-17 13:33:36 Power is up
[1]-[EVENT#8] 2014-09-17 13:33:45 Ethernet device number changed : 0 --> 1
[2]-[EVENT#5] 2014-09-17 13:33:55 WWAN registration status changed : Not registered
--> Registered to home network
[3]-[EVENT#7] 2014-09-17 13:34:01 WWAN network changed : 2G(EGPRS) --> 3G(UMTS)
[4]-[EVENT#6] 2014-09-17 13:34:02 Cell ID changed : 11461 --> 15224144
[5]-[EVENT#6] 2014-09-17 13:34:10 Cell ID changed : 15224144 --> 15224145
[6]-[EVENT#3] 2014-09-17 13:34:14 Profile 1 WWAN status changed : down --> up
[7]-[EVENT#4] 2014-09-17 13:34:17 WWAN IP address changed : N/A --> 10.100.224.78
[8]-[EVENT#6] 2014-09-17 01:34:35 Cell ID changed : 15224145 --> 15209663
[9]-[EVENT#6] 2014-09-17 01:36:13 Cell ID changed : 15209663 --> 15224145
[10]-[EVENT#6] 2014-09-17 01:37:48 Cell ID changed : 15224145 --> 15224144
[11]-[EVENT#6] 2014-09-17 01:46:16 Cell ID changed : 15224144 --> 15224147
[12]-[EVENT#3] 2014-09-17 01:47:26 Profile 1 WWAN status changed : up --> down
[13]-[EVENT#4] 2014-09-17 01:47:29 WWAN IP address changed : 10.100.224.78 --> N/A
[14]-[EVENT#6] 2014-09-17 01:50:01 Cell ID changed : 15224147 --> 15224144
```

Figure 118 - Event notification log

Use the **Download event notification history** button to download the log file. The **Update event notification history** button forces a refresh of the log display.

System log settings

To access the System log settings page, click on the **System** menu item then select the **Log** menu on the left and finally select **System log settings** beneath it.

Log data is stored in RAM and therefore, when the unit loses power or is rebooted, it will lose any log information stored in RAM. To ensure that log information is accessible between reboots of the router there are two options:

1. Enable the **Log to non-volatile memory** option
2. Use a remote syslog server

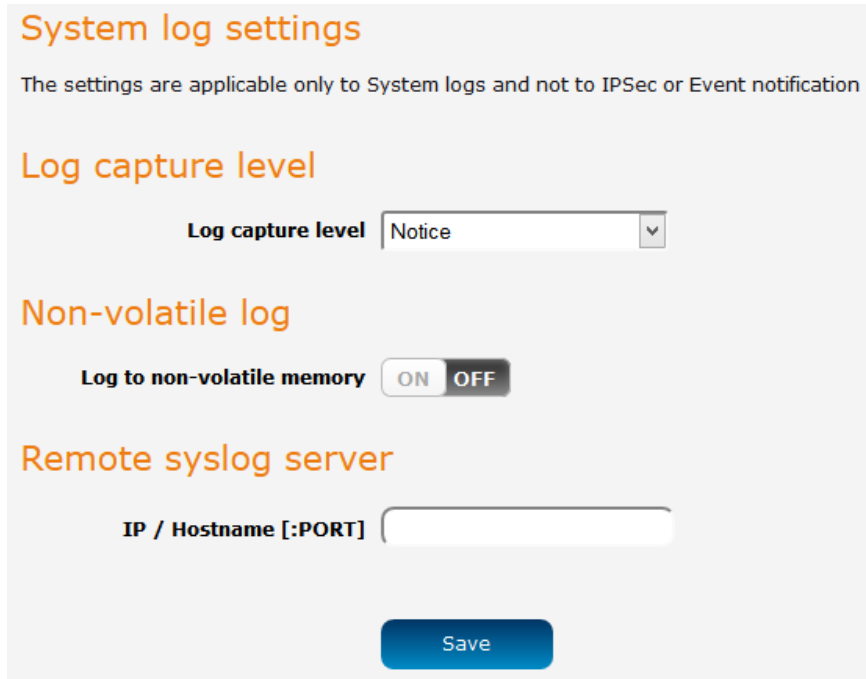

Figure 119 - System log settings

Non-volatile log

When the router is configured to log to non-volatile memory, the log data is stored in flash memory, making it accessible after a reboot of the router. Up to 512kb of log data will be stored before it is overwritten by new log data. Flash memory has a finite number of program-erase operations that it may perform to the blocks of memory. While this number of program-erase operations is quite large, we recommend that you do not enable this option for anything other than debugging to avoid excessive wear on the memory.

Log capture level

The log capture level defines the amount of detail that the system log stores. This setting also affects the Display level setting on the System log page, for example, if this is set to a low level, such as "Error", the System log will not be able to display higher log levels.

Remote syslog server

The router can be configured to output log data to a remote syslog server. This is an application running on a remote computer which accepts and displays the log data. Most syslog servers can also save the log data to a file on the computer on which it is running allowing you to ensure that no log data is lost between reboots.

To configure the NTC-140W Series router to output log data to a remote syslog server:

1. Click on the **System** menu from the top menu bar. The System log item is displayed.
2. Under the **Remote syslog server** section, enter the IP address or hostname of the syslog server in the **IP / Hostname [PORT]** field. You can also specify the port number after the IP or hostname by entering a semi-colon and then the port number e.g. 192.168.1.102:514. If you do not specify a port number, the router will use the default UDP port 514.
3. Click the **Save** button to save the configuration.

Remote syslog server

IP / Hostname [:PORT]

Save

Figure 120 – Remote syslog server configuration

ITEM	DEFINITION
Debug	Show extended system log messages with full debugging level details.
Info	Show informational messages only.
Notice	Show normal system logging information.
Error	Show error condition messages only.

Table 39 - System log detail levels

System configuration

Settings backup and restore

The settings backup and restore page is used to backup or restore the router's configuration or to reset it to factory defaults. In order to view the settings page you must be logged into the web user interface as **root** using the password **admin**. The backup / restore functions can be used to easily configure a large number of NTC-140W Series router by configuring one router with your desired settings, backing them up to a file and then restoring that file to multiple NTC-140W Series routers.

To access the Settings backup and restore page, click on the **System** menu item then select the **System configuration** menu on the left and finally select **Settings backup and restore** beneath it.

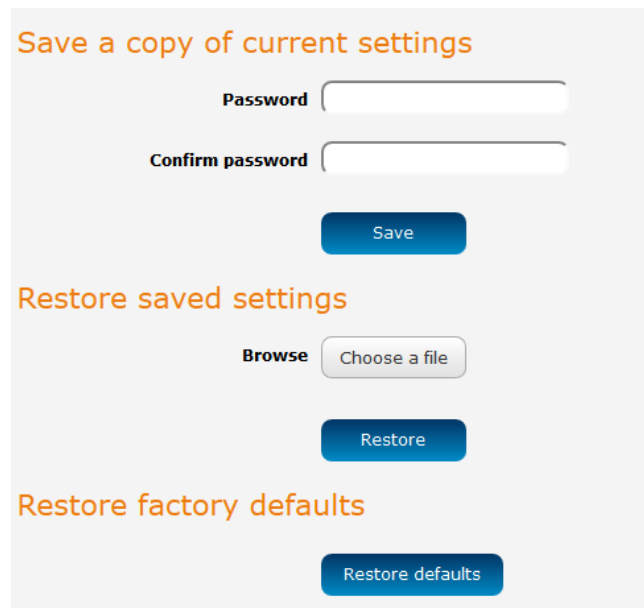

Save a copy of current settings

Password

Confirm password

Save

Restore saved settings

Browse

Restore

Restore factory defaults

Restore defaults

Figure 121 – Settings backup and restore

Back up your router's configuration

Log in to the web configuration interface, click on the **System** menu and select **Settings backup and restore**.

If you want to password protect your backup configuration files, enter your password in the fields under **Save a copy of current settings** and click on **Save**. If you don't want to password protect your files, just click on **Save**. The router will then prompt you to select a location to save the settings file.



Note: The following conditions apply:-

- It is NOT possible to edit the contents of the file downloaded; if you modify the contents of the configuration file in any way you will not be able to restore it later.
- You may change the name of the file if you wish but the filename extension must remain as “.cfg”

Restore your backup configuration

1. In the web configuration interface click on the **System** menu and select **Settings backup and restore**.
2. From the **Restore saved settings** section, click on **Browse** or **Choose a file** and select the backup configuration file on your computer.
3. Click **Restore** to copy the settings to the new NTC-140W Series router. The router will apply these settings and inform you it will reboot - click on **OK**.

Restoring the router's factory default configuration

Click the **Restore defaults** button to restore the factory default configuration. The router asks you to confirm that you wish to restore factory default settings. If you wish to continue with the restoring of factory defaults, click **OK**.



Note: All current settings on the router will be lost when performing a restore of factory default settings. The device IP address will change to 192.168.1.1 and the default username **root** and default password **admin** will be configured.

Upload

To access the Upload page, click on the **System** menu, then **System Configuration** and then **Upload**.

The Upload page allows you to upload firmware files, HTTPS certificates or user created application packages to the NTC-140W Series router. When firmware files have been uploaded, they can also be installed from this page. PDF files, such as this user guide may also be uploaded for access on the router's help page.

For more information on application development, contact NetComm Wireless about our Software Development Kit.



Figure 122 - Upload page

Updating the Firmware

The firmware update process involves first updating the recovery image firmware and then updating the main firmware image.



Note: In order to perform an update, you must be logged into the router with the root manager account (see the [Advanced configuration](#) section for more details).

To update the NTC-140W Series router's firmware:

1. Power on the router as described in the [Installing the router](#) section.
2. Log in to the router with the root user account (See the [Advanced configuration](#) section for details)
3. Select the **System** item from the top menu bar, select the **System configuration** item from the menu on the left and then select the **Upload** menu item.
4. Under the **File uploads** section, click the **Choose a file** button. Locate the recovery firmware image file on your computer and click **Open**. The recovery image is named **ntc_140wx_x.xx.xx.x_r.cdi** while the main system firmware image is named **ntc_140wx_x.xx.xx.x.cdi**.
5. Click the **Upload** button. The firmware image is uploaded to the storage on the router.

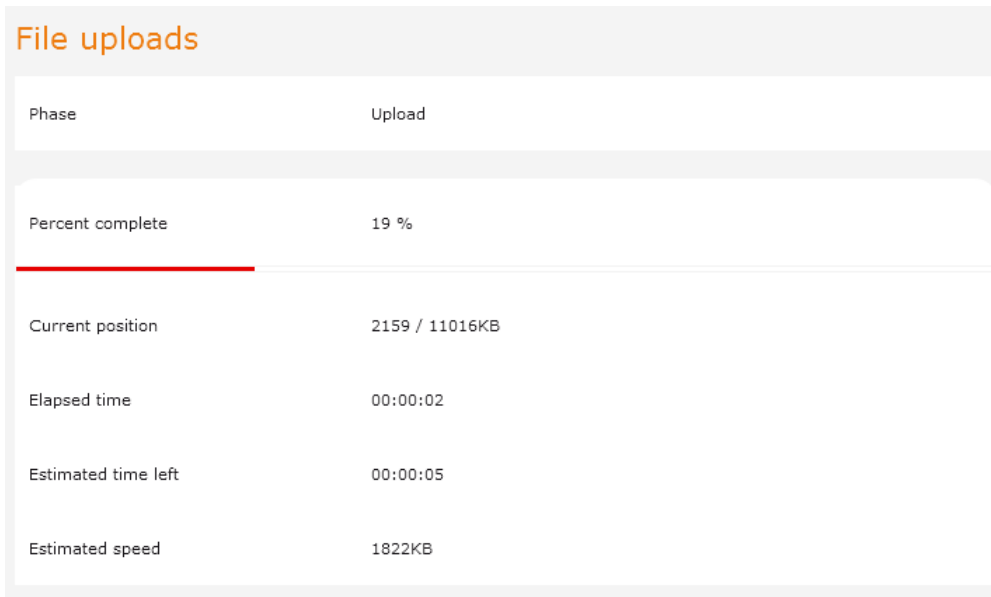

Figure 123 - File upload

- Repeat steps 4 and 5 for the main system firmware image.
- The uploaded firmware images are listed in the **Uploaded files** section. Click the **Install** link next to the recovery image to begin installing the recovery firmware image and then click **OK** on the confirmation window that appears.

File name	Date	Size	Action
ntc_140wx_x.x.xx.x.cdi	Jun 10 2014	32.8M	Install Delete
ntc_140wx_x.x.xx.x_r.cdi	Jun 10 2014	13.8M	Install Delete

Figure 124 - Uploaded files

- The recovery firmware image is flashed and when it is complete, the router displays "The firmware update was successful" and returns to the main Upload screen.

```
Erasing 128 Kibyte @ b20000 -- 92 % complete.
Erasing 128 Kibyte @ b40000 -- 93 % complete.
Erasing 128 Kibyte @ b60000 -- 94 % complete.
Erasing 128 Kibyte @ b80000 -- 95 % complete.
Erasing 128 Kibyte @ ba0000 -- 96 % complete.
Erasing 128 Kibyte @ bc0000 -- 97 % complete.
Erasing 128 Kibyte @ be0000 -- 98 % complete.
Erasing 128 Kibyte @ c00000 -- 100 % complete.
Flashing root_r.ubi to "rfs" (/dev/mtd2)
Writing data to block 55 at offset 0x6e0000
Writing data to block 56 at offset 0x700000
Writing data to block 57 at offset 0x720000
Writing data to block 58 at offset 0x740000
Writing data to block 59 at offset 0x760000
Writing data to block 60 at offset 0x780000
Writing data to block 61 at offset 0x7a0000
Done
Done
Done
The firmware update was successful
```

Close

Figure 125 - Recovery firmware flash process

- Click the **Install** link to the right of the main firmware image you uploaded and then click **OK** to confirm that you want to continue with the installation.



Note: Do not remove the power when the router's LEDs are flashing as this is when the firmware update is in process.

- The installation is complete when the countdown reaches zero. The router attempts to redirect you to the Status page.

```

Writing data to block 190 at offset 0x17c0000
Writing data to block 191 at offset 0x17e0000
Writing data to block 192 at offset 0x1800000
Writing data to block 193 at offset 0x1820000
Writing data to block 194 at offset 0x1840000
Done
Done
Done
The firmware update was successful Reboot to main system...
Estimated time remaining: 47 seconds
Estimated time remaining: 42 seconds
Estimated time remaining: 37 seconds
Estimated time remaining: 32 seconds
Estimated time remaining: 27 seconds
Estimated time remaining: 22 seconds
Estimated time remaining: 17 seconds
Estimated time remaining: 12 seconds
Estimated time remaining: 7 seconds
Estimated time remaining: 2 seconds
Redirecting you to the Status page...
    
```

[Close](#)

Figure 126 — Installing main firmware image

- Hold down the reset button on the router for 15-20 seconds to reboot and restore the factory default settings of the router. See the [Restoring factory default settings](#) section for more information.

Package manager

The Package Manager page is used to provide details of any user installed packages on the router and allow them to be uninstalled.

For more information on application development, contact NetComm Wireless about our Software Development Kit.

To access the Package manager page, click on the **System** menu, **System Configuration** and then **Package manager**.

Package manager					
Application name	Version	Architecture	Time installed		
demonstration_app	1.3	arm	Friday, 6 September 2013 10:06:46 AM	Package details	Uninstall

Figure 127 – Software applications manager

The Application name, Version number of the application, the architecture type and time of installation are all displayed. Clicking the [Package details](#) link will display a pop-up window with further details of the package.

To uninstall any software applications, click the [Uninstall](#) link.

Administration

Administration settings

To access the Administration Settings page, click on the **System** menu then the **Administration** menu on the left and then click on **Administration Settings**.

The Administration settings page is used to enable or disable protocols used for remote access and configure the passwords for the user accounts used to log in to the router.

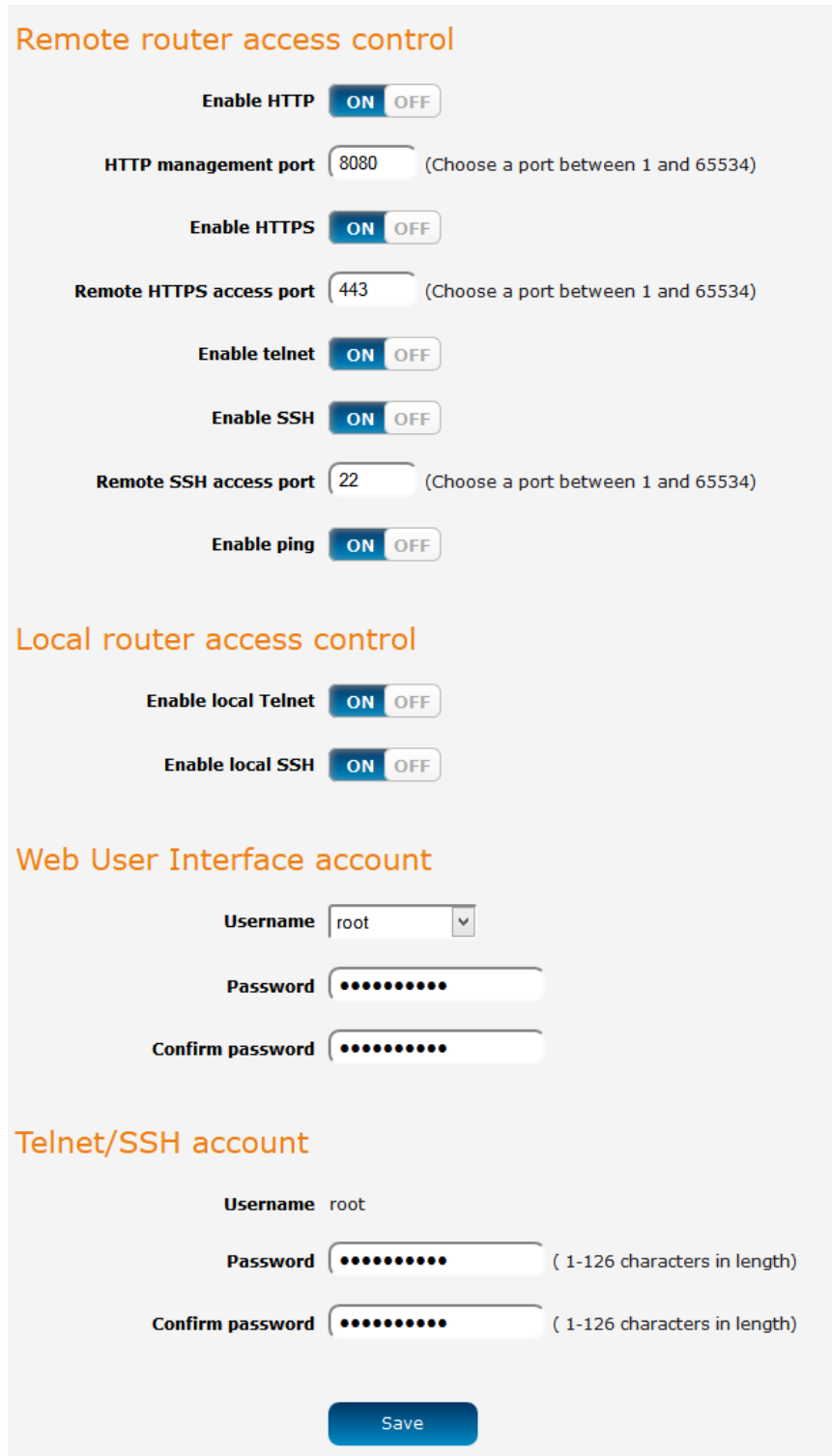

Remote router access control

Enable HTTP ON OFF

HTTP management port (Choose a port between 1 and 65534)

Enable HTTPS ON OFF

Remote HTTPS access port (Choose a port between 1 and 65534)

Enable telnet ON OFF

Enable SSH ON OFF

Remote SSH access port (Choose a port between 1 and 65534)

Enable ping ON OFF

Local router access control

Enable local Telnet ON OFF

Enable local SSH ON OFF

Web User Interface account

Username ▼

Password

Confirm password

Telnet/SSH account

Username

Password (1-126 characters in length)

Confirm password (1-126 characters in length)

Figure 128 - Administration page

OPTION	DEFINITION
Remote router access control	
Enable HTTP	Enable or disable remote HTTP access to the router. You can also set the port you would like remote HTTP access to be available on.
HTTP management port	Enter a port number between 1 and 65534 to use when accessing the router remotely.
Enable HTTPS	Enable or disable remote HTTPS access to the router using a secure connection.
Remote HTTPS access port	Enter a port number between 1 and 65534 to use when accessing the router remotely over a secure HTTPS connection.
Enable Telnet	Enable or disable remote telnet (command line) access to the router.
Enable SSH	Enable or disable Secure Shell on the router.
Remote SSH Access Port	Enter the port number for remote SSH access. Must be a port number between 1 and 65534.
Enable Ping	Enable or disable remote ping responses on the WWAN connection.
Local router access control (Telnet/SSH)	
Web User Interface account	
Username	Use the drop down list to select the root or admin account to change its web user interface password.
Password	Enter the desired web user interface password.
Confirm password	Re-enter the desired web user interface password.
Telnet/SSH account	
Username	Displays the Telnet/SSH.username. This may not be changed.
Password	Enter the desired Telnet/SSH password.
Confirm password	Re-enter the desired Telnet/SSH password.

Table 40 - Administration configuration options

To access the router's configuration pages remotely:

1. Open a new browser window and navigate to the WAN IP address and assigned port number of the router, for example <http://123.209.130.249:8080>



Note: You can find the router's WAN IP address by clicking on the "Status" menu. The WWAN IP field in the WWAN Connection Status section shows the router's WAN IP address.

2. Enter the username and password to login to the router and click **Log in**.



Note: To perform functions like Firmware upgrade, device configuration backup and to restore and reset the router to factory defaults, you must be logged in with the root manager account.



WARNING: Using an insecure password will result in your device being compromised. Any resulting damage may not be covered under warranty. It is strongly advised that the password not be a dictionary word, nor should the same password be used across fleets of devices.

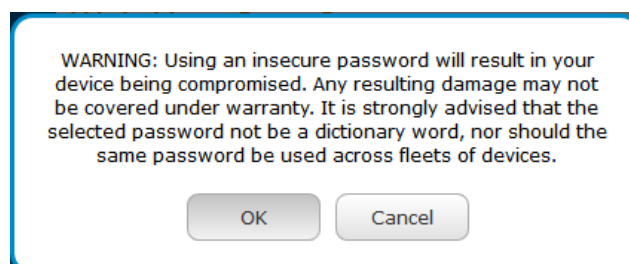

Server certificate

What is HTTP Secure?

HTTP Secure or HTTPS is the use of the HTTP protocol over an SSL/TLS protocol. It is used primarily to protect against eavesdropping of communication between a web browser and the web site to which it is connected. This is especially important when you wish to have a secure connection over a public network such as the internet. HTTPS connections are secured through the use of certificates issued by trusted certificate authorities such as VeriSign. When a web browser makes a connection attempt to a secured web site, a digital certificate is sent to the browser so that it can verify the authenticity of the site using a built-in list of trusted certificate authorities.

There are two main differences between how HTTPS and HTTP connections work:

1. HTTPS uses port 443 while HTTP uses port 80 by default.
2. Over an HTTPS connection, all data sent and received is encrypted with SSL while over an HTTP connection, all data is sent unencrypted.

The encryption is achieved through the use of a pair of public and private keys on both sides of the connection. In cryptography, a key refers to a numerical value used by an algorithm to alter information (encrypt it), making the information secure and visible only to those who have the corresponding key to recover (decrypt) the information. The public key is used to encrypt information and can be distributed freely. The private key is used to decrypt information and must be secret by its owner.

Each NTC-140W Series router contains a self-signed digital certificate which is identical on all NTC-140W Series routers. For a greater level of security, the router also supports generating your own unique key. Additionally, you may use third party software to generate your own self-signed digital certificate or purchase a signed certificate from a trusted certificate authority and then upload those certificates to the router.

Generating your own self-signed certificate

To generate your own self-signed certificate:

1. Click the **System** item from the top menu bar, then **Administration** from the side menu bar and then **Server certificate**.
2. Select a **Server key size**. A larger key size takes longer to generate but provides better security.
3. Click the **Generate** button to begin generating Diffie-Hellman parameters.
4. Enter the certificate details using the appropriate fields. Each field must be completed in order to generate a certificate.

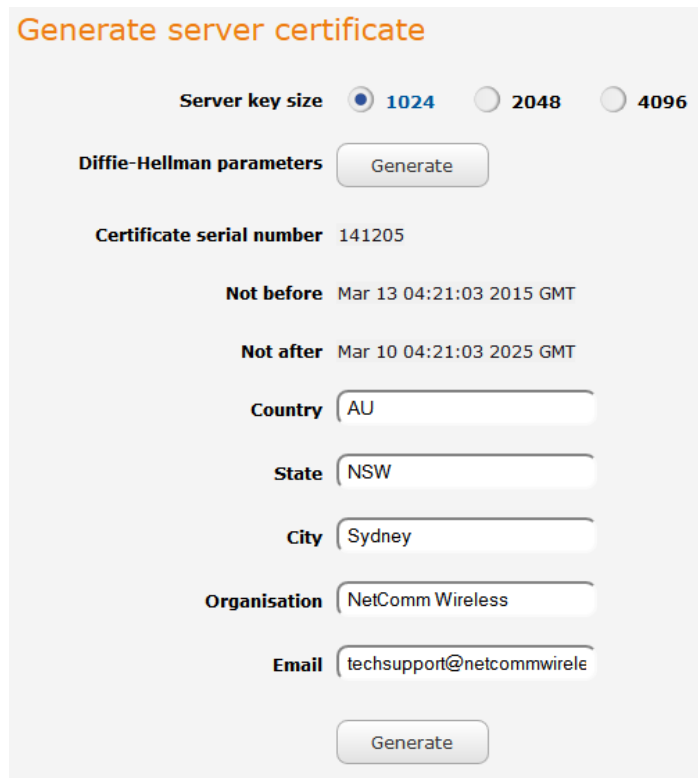

Figure 129 - Generate server certificate



Note: The **Country** field must contain a code for the desired country from the list below.

CODE	COUNTRY	CODE	COUNTRY	CODE	COUNTRY	CODE	COUNTRY
AX	Åland Islands	ER	Eritrea	LS	Lesotho	SA	Saudi Arabia
AD	Andorra	ES	Spain	LT	Lithuania	SB	Solomon Islands
AE	United Arab Emirates	ET	Ethiopia	LU	Luxembourg	SC	Seychelles
AF	Afghanistan	FI	Finland	LV	Latvia	SE	Sweden
AG	Antigua and Barbuda	FJ	Fiji	LY	Libya	SG	Singapore
AI	Anguilla	FK	Falkland Islands (Malvinas)	MA	Morocco	SH	St. Helena
AL	Albania	FM	Micronesia	MC	Monaco	SI	Slovenia
AM	Armenia	FO	Faroe Islands	MD	Moldova	SJ	Svalbard and Jan Mayen
AN	Netherlands Antilles	FR	France	ME	Montenegro	SK	Slovak Republic
AO	Angola	FX	France, Metropolitan	MG	Madagascar	SL	Sierra Leone
AQ	Antarctica	GA	Gabon	MH	Marshall Islands	SM	San Marino
AR	Argentina	GB	Great Britain (UK)	MK	Macedonia	SN	Senegal
AS	American Samoa	GD	Grenada	ML	Mali	SR	Suriname
AT	Austria	GE	Georgia	MM	Myanmar	ST	Sao Tome and Principe
AU	Australia	GF	French Guiana	MN	Mongolia	SU	USSR (former)
AW	Aruba	GG	Guernsey	MO	Macau	SV	El Salvador
AZ	Azerbaijan	GH	Ghana	MP	Northern Mariana	SZ	Swaziland
BA	Bosnia and Herzegovina	GI	Gibraltar	MQ	Martinique	TC	Turks and Caicos Islands
BB	Barbados	GL	Greenland	MR	Mauritania	TD	Chad
BD	Bangladesh	GM	Gambia	MS	Montserrat	TF	French Southern Territories
BE	Belgium	GN	Guinea	MT	Malta	TG	Togo
BF	Burkina Faso	GP	Guadeloupe	MU	Mauritius	TH	Thailand
BG	Bulgaria	GQ	Equatorial Guinea	MV	Maldives	TJ	Tajikistan
BH	Bahrain	GR	Greece	MW	Malawi	TK	Tokelau
BI	Burundi	GS	S. Georgia and S. Sandwich	MX	Mexico	TM	Turkmenistan
BJ	Benin	GT	Guatemala	MY	Malaysia	TN	Tunisia
BM	Bermuda	GU	Guam	MZ	Mozambique	TO	Tonga
BN	Brunei Darussalam	GW	Guinea-Bissau	NA	Namibia	TP	East Timor
BO	Bolivia	GY	Guyana	NC	New Caledonia	TR	Turkey
BR	Brazil	HK	Hong Kong	NE	Niger	TT	Trinidad and Tobago
BS	Bahamas	HM	Heard and McDonald Islands	NF	Norfolk Island	TV	Tuvalu
BT	Bhutan	HN	Honduras	NG	Nigeria	TW	Taiwan
BV	Bouvet Island	HR	Croatia (Hrvatska)	NI	Nicaragua	TZ	Tanzania
BW	Botswana	HT	Haiti	NL	Netherlands	UA	Ukraine
BZ	Belize	HU	Hungary	NO	Norway	UG	Uganda
CA	Canada	ID	Indonesia	NP	Nepal	UM	US Minor Outlying Islands
CC	Cocos (Keeling) Islands	IE	Ireland	NR	Nauru	US	United States
CF	Central African Republic	IL	Israel	NT	Neutral Zone	UY	Uruguay
CH	Switzerland	IM	Isle of Man	NU	Niue	UZ	Uzbekistan
CI	Cote D'Ivoire (Ivory)	IN	India	NZ	New Zealand	VA	Vatican City State (Holy See)
CK	Cook Islands	IO	British Indian Ocean Territory	OM	Oman	VC	Saint Vincent and the
CL	Chile	IS	Iceland	PA	Panama	VE	Venezuela
CM	Cameroon	IT	Italy	PE	Peru	VG	Virgin Islands (British)
CN	China	JE	Jersey	PF	French Polynesia	VI	Virgin Islands (U.S.)
CO	Colombia	JM	Jamaica	PG	Papua New Guinea	VN	Viet Nam
CR	Costa Rica	JO	Jordan	PH	Philippines	VU	Vanuatu
CS	Czechoslovakia (former)	JP	Japan	PK	Pakistan	WF	Wallis and Futuna Islands
CV	Cape Verde	KE	Kenya	PL	Poland	WS	Samoa
CX	Christmas Island	KG	Kyrgyzstan	PM	St. Pierre and	YE	Yemen
CY	Cyprus	KH	Cambodia	PN	Pitcairn	YT	Mayotte
CZ	Czech Republic	KI	Kiribati	PR	Puerto Rico	ZA	South Africa
DE	Germany	KM	Comoros	PS	Palestinian Territory	ZM	Zambia
DJ	Djibouti	KN	Saint Kitts and Nevis	PT	Portugal	COM	US Commercial
DK	Denmark	KR	Korea (South)	PW	Palau	EDU	US Educational
DM	Dominica	KW	Kuwait	PY	Paraguay	GOV	US Government
DO	Dominican Republic	KY	Cayman Islands	QA	Qatar	INT	International
DZ	Algeria	KZ	Kazakhstan	RE	Reunion	MIL	US Military
EC	Ecuador	LA	Laos	RO	Romania	NET	Network
EE	Estonia	LC	Saint Lucia	RS	Serbia	ORG	Non-Profit Organization
EG	Egypt	LI	Liechtenstein	RU	Russian Federation	ARPA	Old style Arpanet
EH	Western Sahara	LK	Sri Lanka	RW	Rwanda		

5. When you have entered all the required details, press the **Generate** button. The certificate takes several minutes to generate. When the certificate has been generated, you are informed that it has been successfully generated and installed. The web server on the router restarts and you are logged out of the router. Click **OK** to be taken back to the login screen.

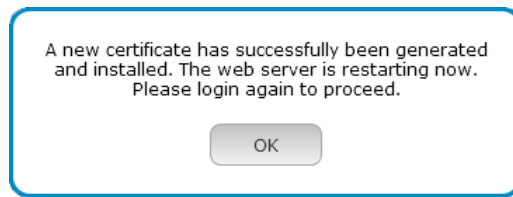

Figure 130 - New certificate successfully generated message

SSH key management

Secure Shell (SSH) is UNIX-based command interface and network protocol used to gain secure access to a remote computer, execute commands on a remote machine or to transfer files between machines. It was designed as a replacement for Telnet and other insecure remote shell protocols which send information, including passwords, as plain text.

SSH uses RSA public key cryptography for both connection and authentication. Two common ways of using SSH are:

- 📶 Use automatically generated public-private key pairs to encrypt the network connection and then use password authentication to log on.
- 📶 Use a manually generated public-private key pair to perform the authentication and allow users or programs to log in without using a password.

To access the SSH key management page, click on the **System** menu then the **Administration** menu on the left and then click on **SSH key management**.

SSH server configuration

SSH protocol

Enable password authentication ON OFF

Enable key authentication ON OFF

Host key management

Key type	Date
ssh_host_key	2014-11-05 11:44:23
ssh_host_dsa_key	2014-11-05 11:44:55
ssh_host_rsa_key	2014-11-05 11:45:12
ssh_host_ecdsa_key	2014-11-05 11:45:13

Client key management

Username	Hostname	Key type

Figure 131 - SSH Server Configuration

SSH Server Configuration

To configure the SSH server settings:

1. Use the SSH Protocol drop down list to select the protocol that you want to use. Protocol 2 is more recent and is considered more secure.
2. Select the types of authentication you want to use by clicking the **Enable password authentication** and **Enable key authentication** toggle keys on or off. Note that you may have both authentication methods on but you may not turn them both off.
3. Click the **Save** button to confirm your settings.

Host key management

SSH keys provide a means of identification using public key cryptography and challenge response authentication. This means that a secure connection can be established without transmitting a password, thereby greatly reducing the threat of someone eavesdropping and guessing the correct credentials.

SSH Keys always come in pairs with one being a public key and the other a private key. The public key may be shared with any server to which you want to connect. When a connection request is made, the server uses the public key to encrypt a challenge (a coded message) to which the correct response must be given. Only the private key can decrypt this challenge and produce the correct response. For this reason, the private key should not be shared with those who do not wish to give authorization.

The Host key management section displays the current public keys on the router and their date and timestamp. These public keys are provided in different formats, including DSA, RSA and ECDSA. Each format has advantages and disadvantages in terms of signature generation speed, validation speed and encryption/decryption speed. There are also compatibility concerns to consider with older clients when using ECDSA, for example.

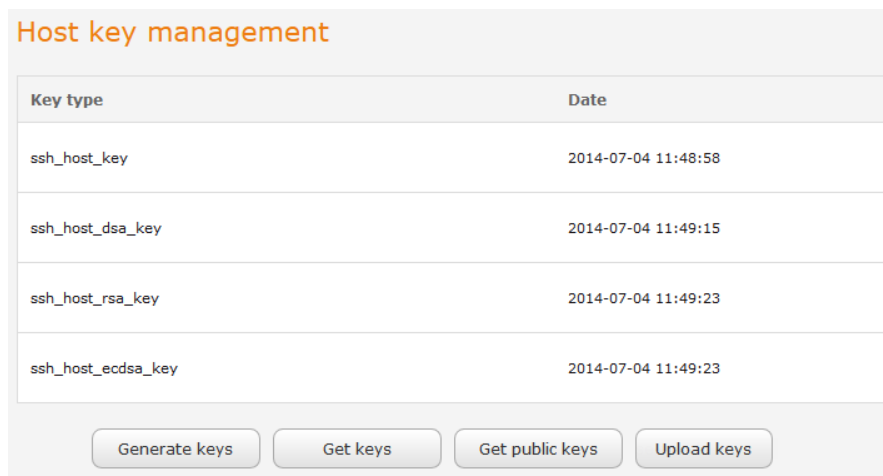

Host key management

Key type	Date
ssh_host_key	2014-07-04 11:48:58
ssh_host_dsa_key	2014-07-04 11:49:15
ssh_host_rsa_key	2014-07-04 11:49:23
ssh_host_ecdsa_key	2014-07-04 11:49:23

Generate keys Get keys Get public keys Upload keys

Generating new keys

The complete set of keys can be re-generated by selecting the **Generate keys** button. This key generation process takes approximately 30 seconds to complete.

Downloading keys

The **Get keys** button allows you to download the complete set of public and private keys while the **Get public keys** button will download only the set of public keys.

Uploading your own key files

You can generate your own SSH keys and upload them to the router. To generate keys on a Linux-based machine, use the following commands:

```
mkdir keys
cd keys
ssh-keygen -t rsa1 -f ssh_host_key -N ""
ssh-keygen -t dsa -f ssh_host_dsa_key -N ""
ssh-keygen -t rsa -f ssh_host_rsa_key -N ""
ssh-keygen -t ecdsa -f ssh_host_ecdsa_key -N ""
zip -e -P "PASSWORDHERE" -j keys.zip *
```

Click the **Upload keys** button then locate the generated keys to upload them to the router.

Client key management

The Client Key Management section is used for uploading the public key file of clients. To upload a client public key, click the **Upload** button, browse to the file and click **Open**.

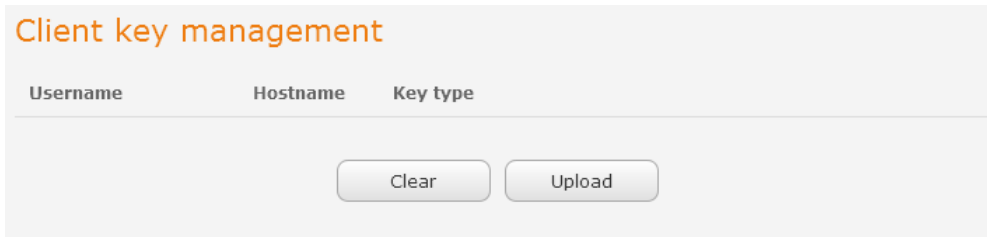

When the file is uploaded, it is examined for validity. If the key file is not a valid public key, it will not be uploaded.

LED operation mode

The 8 front LED indicators may be turned off after a timeout period for aesthetic or power saving reasons. To access the LED Operation Mode page, click the **System** menu, then **Administration** on the left and finally select **LED Operation Mode**.

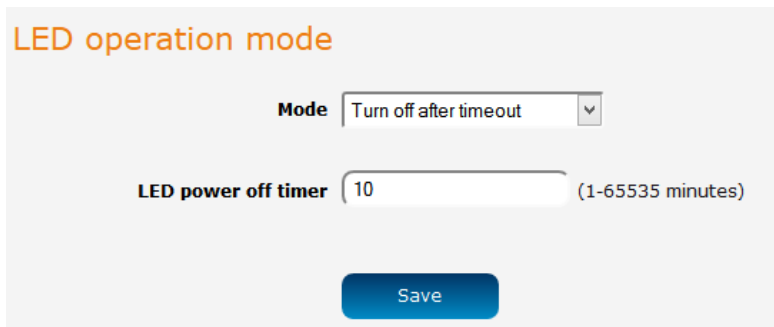

Figure 132 - LED Operation Mode

The **Mode** drop down list sets the operation mode of the LEDs on the front panel of the router. To set the lights to operate at all times, set this to Always on. To set the lights to turn off after a specified period, select **Turn off after timeout**. When configured to turn off after timeout, use the **LED power off timer** field to specify the time in minutes to wait before turning off the LED indicators. The LED Power Off Timer must be an integer between 1 and 65535.

The wait period begins from the time the **Save** button is clicked. When the wait period expires, the LEDs will turn off. If the router is rebooted, the LED power off timer is reset. The router will boot up and wait for the configured time before turning off again.

Watchdogs

To access the Watchdogs page, click the **System** menu item, then select the **Watchdogs** menu item on the left.

Watchdogs settings

When configured, the watchdog feature transmits controlled ping packets to 1 or 2 user specified IP addresses. Should the watchdog not receive responses to the pings, it will reboot the device in a last resort attempt to restore connectivity.

Please be very careful when considering using this feature in situations where the device is intentionally offline for a particular reason (e.g user configured PDP session disconnect, or the connect on demand feature enabled). This is because the watchdog feature expects to be able to access the internet at all times, and will always eventually reboot the router if access isn't restored by the time the various timers and retries expire.

It is due to the nature of the watchdog being a last resort standalone backup mechanism that it will continue to do its job and reboot the device even when the connect on demand session is idle, or the PDP context is disabled by the user. Therefore, it is recommended to disable this feature if connect on demand is configured, or if the PDP context is intentionally disconnected on occasion.

This feature operates as follows:

A. After every "Periodic Ping timer" configured interval, the router sends 3 consecutive pings to the "First destination address".
B. If all 3 pings fail the router sends 3 consecutive pings to the "Second destination address".
C. The router then sends 3 consecutive pings to the "First destination address" and 3 consecutive pings to the "Second destination address" every "Periodic Ping accelerated timer" configured interval.
D. If all accelerated pings in step C above fail the number of times configured in "Fail count", the router reboots.
E. If any ping succeeds the router returns to step A and does not reboot.

Note: The "Periodic Ping timer" should never be set to a value less than 300 seconds- this is to allow the router time to reconnect to the cellular network following a reboot.

To disable the Watchdog, simply set "Fail count" to 0

First destination address

Second destination address

Periodic Ping timer (0=disable, 300-65535) secs

Periodic Ping accelerated timer (0=disable, 60-65535) secs

Fail count (0=disable, 1-65535) times

Periodic reboot

Force reboot every (0=disable, 5-65535) mins

Randomize reboot time

Figure 133 - Watchdogs Settings

Watchdogs are features which monitor the router for anomalies and restart the router if an anomaly occurs preventing its normal operation. When configured, the watchdogs feature transmits controlled ping packets to 1 or 2 user specified IP addresses to confirm an active connection. If the watchdog does not receive responses to the pings after a specified number of failures, it will reboot the device in a last resort attempt to restore connectivity.

We recommend using caution when implementing this feature in situations where the device is intentionally offline for a particular reason, for example, when Connect-on-demand has been enabled. This is because the watchdog expects to be able to access the internet at all times, and will always eventually reboot the router if access isn't restored by the time the various timers expire and the fail count is reached.

It is due to the nature of the watchdog being a last resort standalone backup mechanism that it will continue to do its job and reboot the device even when the Connect-on-demand session is idle, or the PDP context is disabled by the user. Therefore, we recommended that you disable this feature if Connect-on-demand is configured or if the PDP context is intentionally disconnected on occasion.

The watchdog works as follows:

- a) The router sends 3 consecutive pings to the first destination address at the interval specified in the **Periodic Ping timer** field.
- b) If all 3 pings to the first destination address fail, the router sends 3 consecutive pings to the second destination address at the **Periodic Ping timer** interval.
- c) If all 3 pings to the second destination address fail, the router sends 3 pings to the first destination address using the **Periodic Ping accelerated timer** interval.
- d) If all 3 accelerated pings to the first destination address fail, the router sends 3 pings to the second destination address at the **Periodic Ping accelerated timer** interval.
- e) If all 3 accelerated pings to the second destination address fail, the router registers this as a fail and returns to step C.
- f) When the number of failures reaches the number configured in the **Fail count** field, the router reboots. If any ping succeeds, the router returns to step A and does not reboot.



Note: The **Periodic Ping timer** should not be set to a value of less than 300 seconds to allow the router time to reconnect to the cellular network following a reboot.

To disable the periodic ping reset monitor, set **Fail count** to 0.

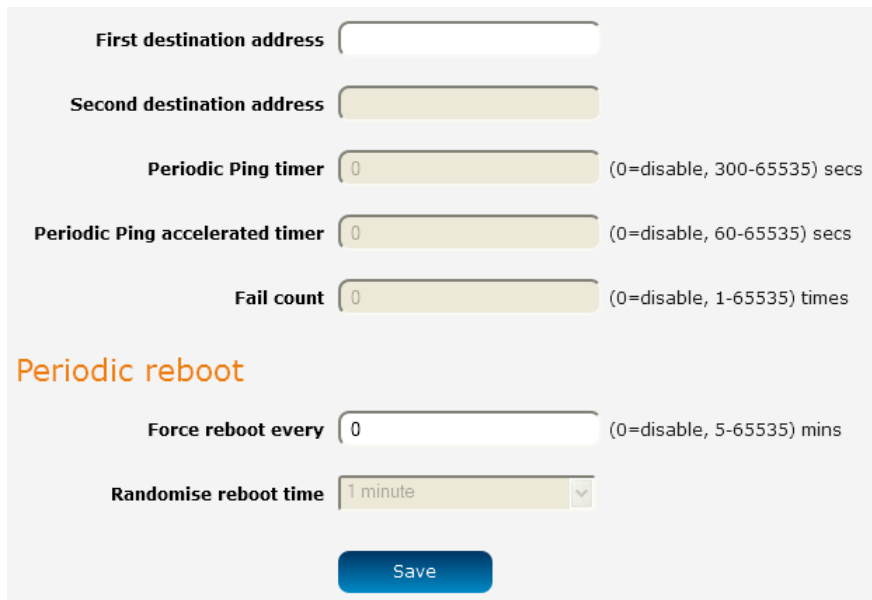

The screenshot shows a configuration page for the Ping watchdog settings. It includes the following fields:

- First destination address**: An empty text input field.
- Second destination address**: An empty text input field.
- Periodic Ping timer**: A numeric input field with the value '0'. To its right, the text '(0=disable, 300-65535) secs' is displayed.
- Periodic Ping accelerated timer**: A numeric input field with the value '0'. To its right, the text '(0=disable, 60-65535) secs' is displayed.
- Fail count**: A numeric input field with the value '0'. To its right, the text '(0=disable, 1-65535) times' is displayed.

Below these fields is a section titled **Periodic reboot** in orange text, containing:

- Force reboot every**: A numeric input field with the value '0'. To its right, the text '(0=disable, 5-65535) mins' is displayed.
- Randomise reboot time**: A dropdown menu currently showing '1 minute'.

At the bottom of the form is a blue button labeled **Save**.

Figure 134 – Ping watchdog settings

Configuring Periodic Ping settings

The Periodic Ping settings configure the router to transmit controlled ping packets to 2 specified IP addresses. If the router does not receive responses to the pings, the router will reboot.

To configure the ping watchdog:

1. In the **First destination address** field, enter a website address or IP address to which the router should send the first round of ping requests.
2. In the **Second destination address** field, enter a website address or IP address to which the router should send the second round of ping requests.
3. In the **Periodic Ping timer** field, enter an integer between 300 and 65535 for the number of seconds the router should wait between ping attempts. Setting this to 0 disables the ping watchdog function.
4. In the **Periodic Ping accelerated timer** field, enter an integer between 60 and 65535 for the number of seconds the router should wait between accelerated ping attempts, i.e. pings to the second destination address. Setting this to 0 disables the ping watchdog function.
5. In the **Fail count** field, enter an integer between 1 and 65535 for the number of times an accelerated ping should fail before the router reboots. Setting this to 0 disables the ping watchdog function.

Disabling the Periodic Ping reset function

To disable the Periodic Ping reset function, set **Fail count** to 0.



Note: The traffic generated by the periodic ping feature is usually counted as chargeable data usage. Please keep this in mind when selecting how often to ping.

Configuring a Periodic reboot

The router can be configured to automatically reboot after a period of time specified in minutes. While this is not necessary, it does ensure that in the case of remote installations, the router will reboot if some anomaly occurs.

1. In the **Force reboot every** field, enter the time in minutes between forced reboots. The default value is 0 which disables the Periodic reboot function. The minimum period between reboots is 5 minutes while the maximum value is 65535 minutes.
2. If you have configured a forced reboot time, you can use the **Randomise reboot time** drop down list to select a random reboot timer. Randomising the reboot time is useful for preventing a large number of devices from rebooting simultaneously and flooding the network with connection attempts. When configured, the router waits for the configured **Force reboot every** time and then reboots after waiting for a random period that is less than or equal to the **Randomise reboot time** setting.
3. Click the **Save** button to save the settings.



Note: The randomise reboot time is not persistent across reboots; each time the router is due to reboot, it randomly selects a time less than or equal to the **Randomise reboot time**.

Power management

The Power management page provides you with an overview of the power profiles and the ability to configure them. Up to five power profiles may be configured and all of them may be active simultaneously. The Status column indicates whether the profile is active, while the Sleep mode and Wake mode columns summarise the method used to sleep or wake the modem.

To access the Power management page, click the **System** menu item, then select the **Power management** menu item on the left.



Note: When configuring multiple power profiles, be careful so that they do not overlap or conflict with one another, for example, configuring a schedule which wakes up the unit when another profile has it scheduled to be in low power mode.

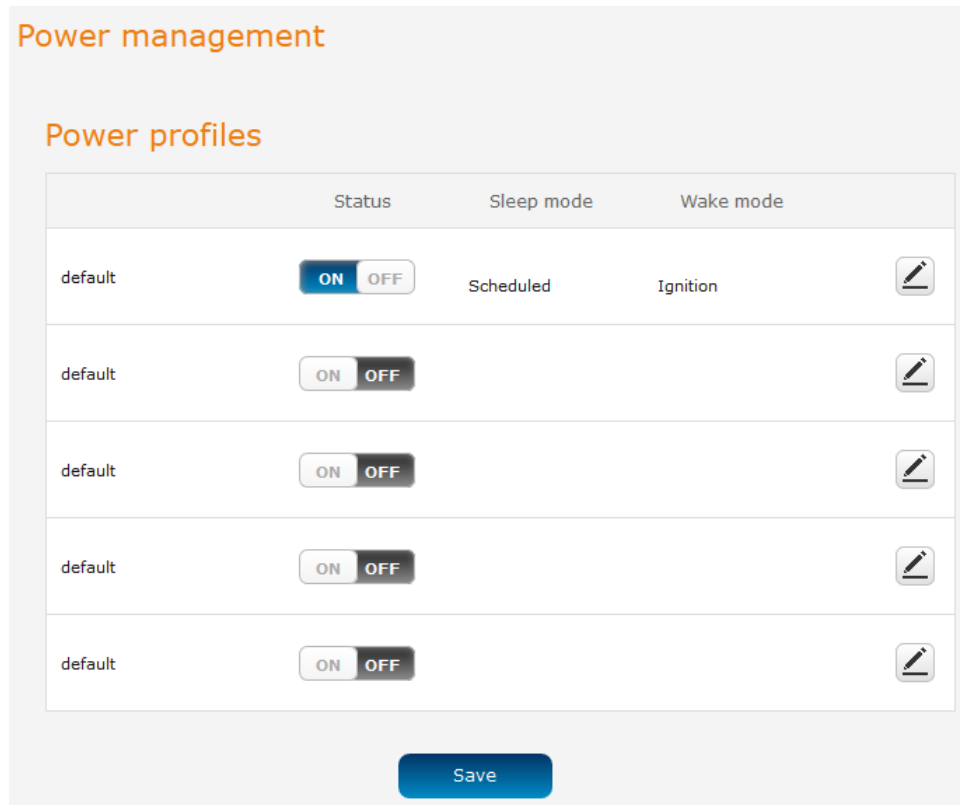

Power management

Power profiles





	Status	Sleep mode	Wake mode	
default	<input checked="" type="checkbox"/> ON <input type="checkbox"/> OFF	Scheduled	Ignition	
default	<input type="checkbox"/> ON <input checked="" type="checkbox"/> OFF			
default	<input type="checkbox"/> ON <input checked="" type="checkbox"/> OFF			
default	<input type="checkbox"/> ON <input checked="" type="checkbox"/> OFF			
default	<input type="checkbox"/> ON <input checked="" type="checkbox"/> OFF			

Figure 135 - Power management

To edit a power profile, click the Edit  icon of the appropriate profile.

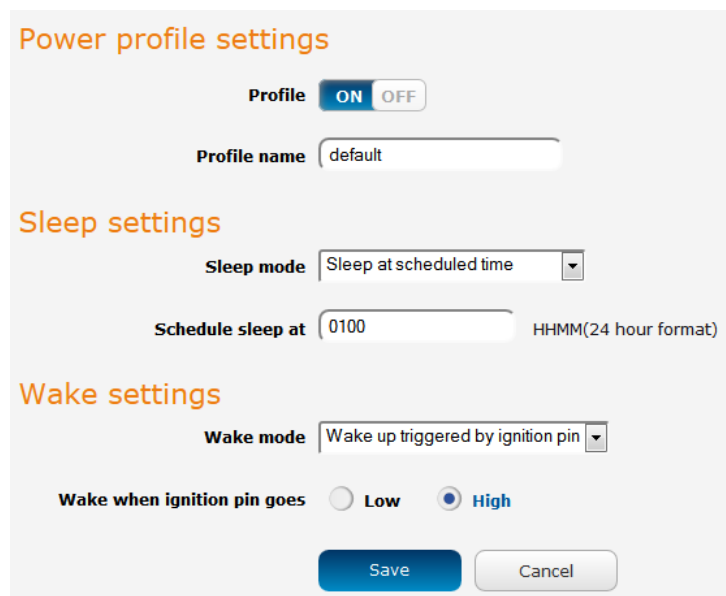

Power profile settings

Profile ON OFF

Profile name

Sleep settings

Sleep mode

Schedule sleep at HHMM(24 hour format)

Wake settings

Wake mode

Wake when ignition pin goes Low High

Figure 136 - Power management - Power profile settings

Sleep settings

Use the **Sleep mode** drop down list to select a condition under which the router should enter the sleep state.

Sleep after timer

When this mode is selected, the router will enter the sleep state after the number of minutes specified in the **Sleep after** field, regardless of the state of the ignition pin.

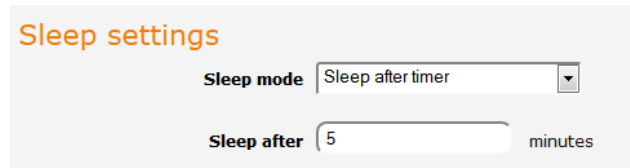

The screenshot shows the 'Sleep settings' section with the 'Sleep mode' dropdown set to 'Sleep after timer'. Below it, the 'Sleep after' field contains the number '5' and is followed by the text 'minutes'.

Figure 137 - Sleep after timer

Sleep at scheduled time

When this mode is selected, the router goes to sleep at the time specified in the **Schedule sleep at** field, regardless of the state of the ignition pin. Enter the time in 24 hour format without the semi-colon.

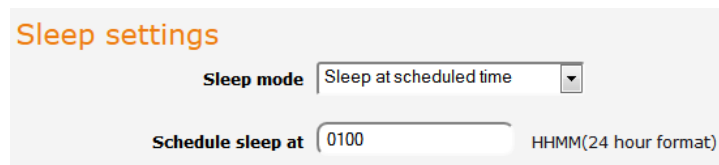

The screenshot shows the 'Sleep settings' section with the 'Sleep mode' dropdown set to 'Sleep at scheduled time'. Below it, the 'Schedule sleep at' field contains the time '0100' and is followed by the text 'HHMM(24 hour format)'.

Figure 138 - Sleep at scheduled time

Sleep triggered by ignition pin

This mode sets the router to enter sleep state when the signal on the ignition pin reaches the specified value.

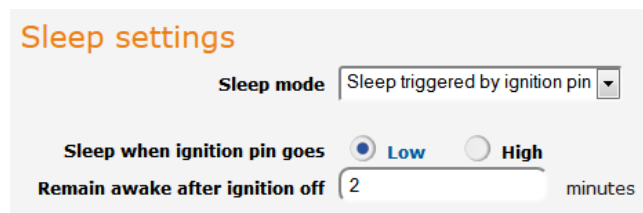

The screenshot shows the 'Sleep settings' section with the 'Sleep mode' dropdown set to 'Sleep triggered by ignition pin'. Below it, there are two radio buttons for 'Sleep when ignition pin goes': 'Low' (selected) and 'High'. At the bottom, the 'Remain awake after ignition off' field contains the number '2' and is followed by the text 'minutes'.

Figure 139 - Sleep triggered by ignition pin

Use the **Sleep when ignition pin goes** setting to select **Low** or **High**. By default, this is set to **Low**. Additionally, the router will stay on for the number of minutes specified in the **Remain awake after ignition off** field. The minimum value for this field is 2 minutes with the maximum being 255 minutes.

Wake settings

Use the **Wake mode** drop down list to select a condition under which the router should return from the sleep state.

Wake triggered by ignition pin

This mode sets the router to wake up when the signal on the ignition pin reaches the specified value.

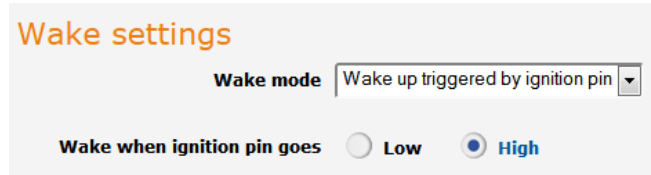

The screenshot shows the 'Wake settings' section. The 'Wake mode' dropdown menu is set to 'Wake up triggered by ignition pin'. Below it, there are two radio button options: 'Low' and 'High'. The 'High' option is selected, indicated by a blue dot.

Figure 140 - Wake up triggered by ignition pin

Use the **Wake up when ignition pin goes** setting to select **Low** or **High**. By default, this is set to **High**.

Wake up at scheduled time

When this mode is selected, the router wakes up at the time specified in the **Schedule wake up at** field, regardless of the state of the ignition pin. Enter the time in 24 hour format without the semi-colon.

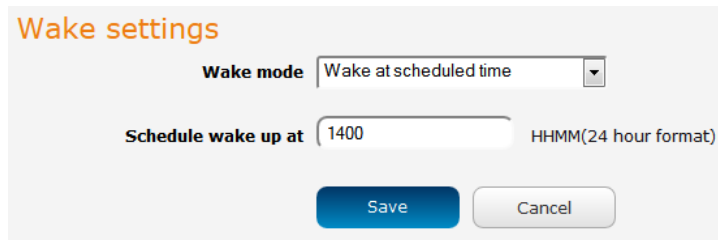

The screenshot shows the 'Wake settings' section. The 'Wake mode' dropdown menu is set to 'Wake at scheduled time'. Below it, there is a text input field for 'Schedule wake up at' containing the value '1400'. To the right of the input field is the text 'HHMM(24 hour format)'. At the bottom of the form are two buttons: 'Save' and 'Cancel'.

Figure 141 - Wake up at scheduled time

Enter the time in seconds to wait before returning from sleep state in the **Always wake up after** field. A setting of 0 means that the router will automatically wake from sleep state immediately.

USB-OTG

The USB-OTG page displays the current status of the USB port, i.e. whether it is in Device mode or Host mode. By default, Automatic mode is set to ON, allowing the router to intelligently choose the correct mode. If you wish to manually override this selection, you can turn off Automatic mode and set Host or Device mode yourself.

To access the USB OTG page, click the **System** menu item, then select the **USB OTG** menu item on the left.

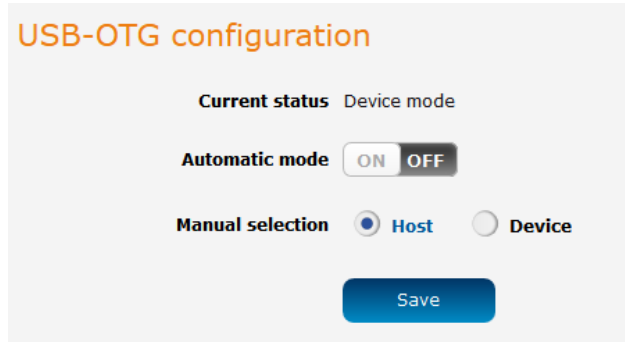

Figure 142 - USB-OTG configuration

Storage

The Storage page provides configuration options with relation to USB and SD storage devices. To access the Storage page, click the **System** menu item, then select the **Storage** menu item on the left.

Storage device list

The Storage devices list displays any connected storage devices and summarises the type, file system, size, used and available space on each device. Additionally, an eject button is provided to unmount the storage device so you can safely remove it.

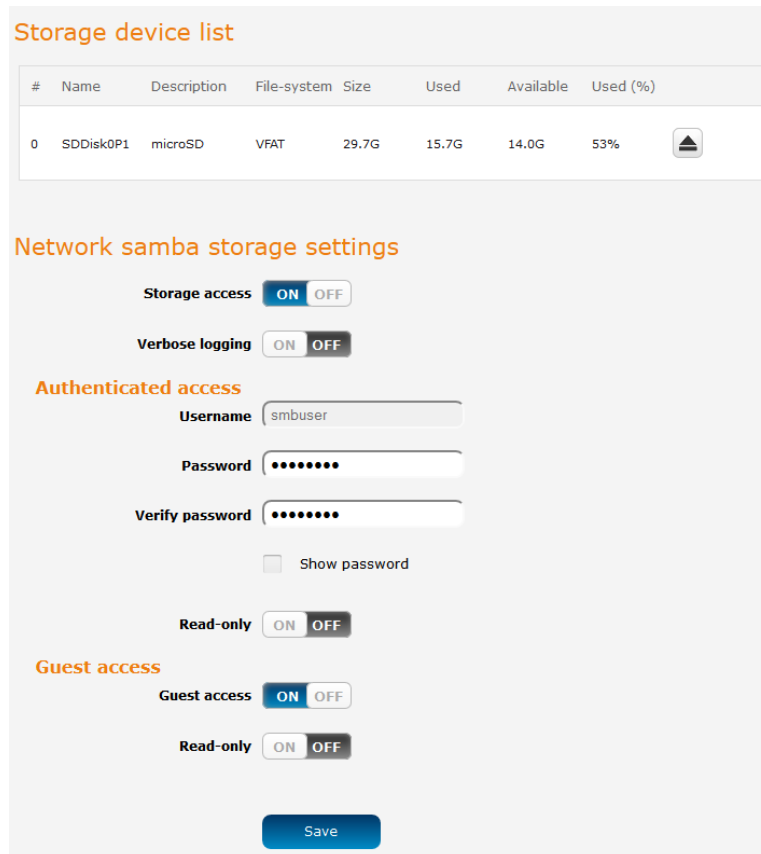

Storage device list

#	Name	Description	File-system	Size	Used	Available	Used (%)	
0	SDDisk0P1	microSD	VFAT	29.7G	15.7G	14.0G	53%	

Network samba storage settings

Storage access ON OFF

Verbose logging ON OFF

Authenticated access

Username

Password

Verify password

Show password

Read-only ON OFF

Guest access

Guest access ON OFF

Read-only ON OFF

Figure 143 - Storage

Network Samba storage settings

Storage devices connected to the router can be shared using the Samba protocol. The table below describes the configuration options for the Network Samba storage settings.

ITEM	DEFINITION
Storage access	Turns the Samba sharing function on or off.
Verbose logging	When turned on, this provides additional logging data in the system log. This should generally only be used when debugging to avoid generating excessively long logs.
Authenticated access	
Username	The username to be used for authenticated access to the storage device. This is configured as 'smbuser' and cannot be changed.
Password	The password to be used for authenticated access to the storage device.
Verify password	The password to be used for authenticated access to the storage device.
Show password	Displays the passwords in the authenticated access fields.
Read-only	When turned on, this provides read-only access to the files on the connected storage device(s). When read-only access for authenticated accounts is turned on, the guest access read-only option is hidden and guests are permitted read-only access also.
Guest access	
Guest access	Enables or disables guest access to the storage device.
Read-only	When turned on, this provides read-only access to the files on the connected storage device(s) for guest users. If the authenticated account has Read-only enabled then this option is not available and read-only access is automatically granted to guest users.

Table 41 - Network Samba storage settings

Reboot

The reboot option in the System section performs a soft reboot of the router. This can be useful if you have made configuration changes you want to implement.

To reboot the router:

1. Click the **System** menu item from the top menu bar.
2. Click the **Reboot** button from the menu on the left side of the screen.

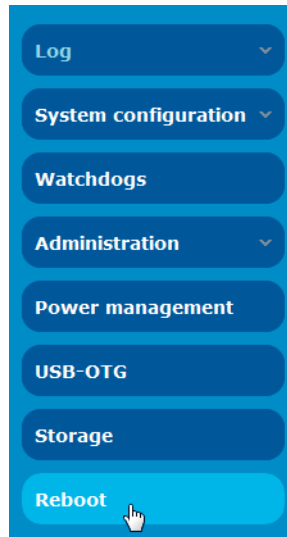

Figure 144 - Reboot menu option

3. The router displays a warning that you are about to perform a reboot. If you wish to proceed, click the **Reboot** button then click **OK** on the confirmation window which appears.

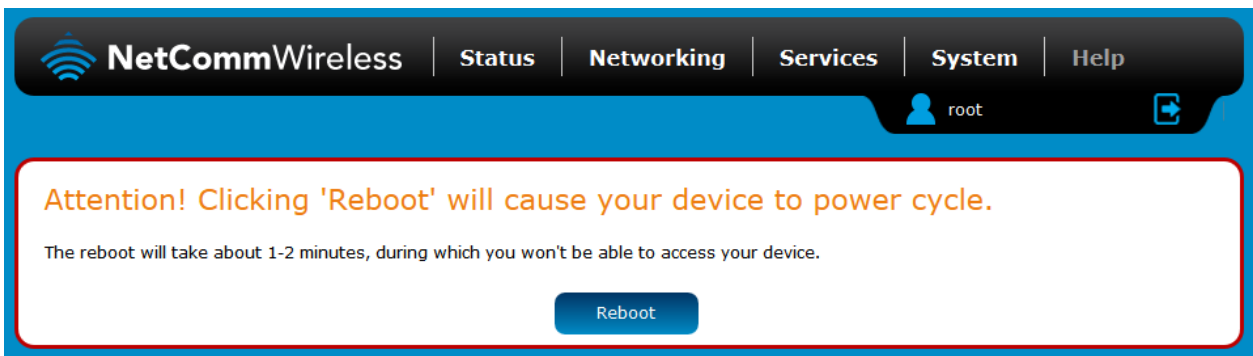



Figure 145 - Reboot confirmation



Note: It can take up to 2 minutes for the router to reboot.

Logging out

To log out of the router, click the  icon at the top right corner of the web user interface.

Appendix A: Tables

Table 1 - Document Revision History	3
Table 2 - Device Dimensions.....	8
Table 3 - LED Indicators	9
Table 4 - Signal strength LED descriptions.....	10
Table 5 - Ethernet port LED indicators description.....	11
Table 6 – Interfaces.....	12
Table 7 - Locking power block pin outs.....	16
Table 8 - Management account login details – Root manager details – Admin manager.....	17
Table 9 - Management account login	
Table 10 - Status page item details	21
Table 11 - Data connection item details	23
Table 12 - Connect on demand - Connect and disconnect timers descriptions	28
Table 13 - Wireless Configuration - Basic Configuration Items	39
Table 14 - Wireless Settings – SSID and Security Settings	40
Table 15 - Wireless Settings - Advanced Configuration Items.....	41
Table 16 – Wireless hotspot settings	44
Table 17 - Wireless settings – Client Configuration	45
Table 18 - Ethernet group configuration items	47
Table 19 - Ethernet WAN configuration options.....	48
Table 20 - Failover configuration - Hardware link monitoring.....	51
Table 21 - Failover configuration - Ping monitoring	51
Table 22 - Current MAC / IP / Port filtering rules in effect.....	60
Table 23 - IPSec Configuration Items	63
Table 24 - Odometer configuration options	87
Table 25 - IO configuration options	88
Table 26 - IO pin modes	89
Table 27 - Event notification configuration options.....	91
Table 28 - Event notification – event types	91
Table 29 - Email client settings.....	93
Table 30 - SMS Setup Settings.....	95
Table 31 - Inbox/Outbox icons.....	97
Table 32 - SMS Diagnostic Command Syntax.....	102
Table 33 - List of basic SMS diagnostic commands	103
Table 34 - List of get/set commands.....	105
Table 35 - List of basic SMS diagnostics RDB variables	105
Table 36 - Network types returned by get plmnscan SMS command	106
Table 37 - Operator status codes returned by get plmnscan SMS command	106
Table 38 - SMS diagnostics example commands.....	109
Table 39 - System log detail levels	114
Table 40 - Administration configuration options.....	120
Table 41 - Network Samba storage settings	134
Table 42 - LAN Management Default Settings.....	137
Table 43 - Web Interface Default Settings	137
Table 44 - Telnet Access	137
Table 45 - RJ-45 connector pin outs.....	144
Table 46 - Technical Specifications of the NTC-140W-01 and NTC-140W-02 routers	153

Appendix B: Default Settings

The following tables list the default settings for the NTC-140W Series router.

LAN (MANAGEMENT)	
Static IP Address:	192.168.1.1
Subnet Mask:	255.255.255.0
Default Gateway:	192.168.1.1

Table 42 - LAN Management Default Settings

ADMIN MANAGER ACCOUNT		ROOT MANAGER ACCOUNT	
Username:	admin	Username:	root
Password:	admin	Password:	admin

Table 43 - Web Interface Default Settings



Note: The admin manager account allows you to manage all settings of the router except functions such as firmware upgrade, device configuration backup and restore and reset to factory default settings, which are privileged only to the root manager account.

NTC-140W SERIES ROUTER TELNET ACCESS	
Username:	root
Password:	admin

Table 44 - Telnet Access

Restoring factory default settings

Restoring factory defaults will reset the NTC-140W Series router to its factory default configuration. You may encounter a situation where you need to restore the factory defaults on your NTC-140W Series router such as:

- 🔌 You have lost your username and password and are unable to login to the web configuration page;
- 🔌 You are asked to perform a factory reset by support staff.

There are two methods you can use to restore factory default settings on your NTC-140W Series router:

- 🔌 Using the web-based user interface
- 🔌 Using the reset button on the interface panel of the router

Using the web-based user interface

To restore your router to its factory default settings, please follow these steps:

1. Open a browser window and navigate to the IP address of the router (default address is <http://192.168.1.1>). Login to the router using **root** as the User Name and **admin** as the password.
2. Click the **System** item from the top menu bar, then **System configuration** on the left menu and then click **Settings backup and restore**.
3. Under the **Restore factory defaults** section, click the **Restore defaults** button. The router asks you to confirm that you wish to restore factory defaults. Click **OK** to continue. The router sets all settings to default. Click **OK** again to reboot the router.
4. When the Power light returns to a steady red, the reset is complete. The default settings are now restored.

Using the reset button on the interface panel of the router

Use a pen to depress the Reset button on the device for 15-20 seconds. The router will restore the factory default settings and reboot.

When you have reset your NTC-140W Series router to its default settings you will be able to access the device's configuration web interface using <http://192.168.1.1> with username **admin** or **root** and password **admin**.

Appendix C: Recovery mode

The NTC-140W Series Router features two independent operating systems, each with its own file systems. These two systems are referred to as 'Main' and 'Recovery'. It is always possible to use one in order to restore the other in the event that one system becomes damaged or corrupted (such as during a firmware upgrade failure). The recovery console provides limited functionality and is typically used to restore the main firmware image in the case of a problem.

Accessing recovery mode

Both systems have web interfaces that can be used to manipulate the other inactive system. The NTC-140W Series Router starts up by default in the Main system mode, however the router may be triggered to start in recovery mode if desired.

To start the router in recovery mode:

1. Press and hold the physical reset button on the interface panel of the router for 5 to 15 seconds. When the LEDs on the front panel change to amber and countdown in a sequence, release the reset button. The router then boots into recovery mode.
2. In your browser, navigate to <http://192.168.1.1>. The router's recovery mode is hardcoded to use this address regardless of the IP address that was configured in the main system. The router's recovery console is displayed.

NetComm Cellular Router Recovery Console

Status	Log	Application Installer	Settings	Reboot
Status				
System Information				
System Up time	00:01:19			
Router Version	Hardware: 1.0 Software: XXXXXXXX			
Serial Number	164199131700017			
Trigger	button			
LAN				
IP	192.168.1.1 / 255.255.255.0			
MAC Address	00:60:64:B2:D4:22			
Ethernet Port Status				
LAN: 	Up / 100.0 Mbps / FDX			

Figure 146 - Recovery console

Status

The status page provides basic information such as the system up time, hardware and software router versions, the router's serial number, the method used to trigger the recovery mode, the IP and MAC address of the router and the status of the Ethernet port.

NetComm Cellular Router Recovery Console

Status	Log	Application Installer	Settings	Reboot
Status				
System Information				
System Up time	00:01:19			
Router Version	Hardware:1.0 Software: XXXXXXXX			
Serial Number	164199131700017			
Trigger	button			
LAN				
IP	192.168.1.1 / 255.255.255.0			
MAC Address	00:60:64:B2:D4:22			
Ethernet Port Status				
LAN: 	Up / 100.0 Mbps / FDX			

Figure 147 - Recovery mode - Status

Log

The log page displays the system log which is useful in troubleshooting problems which may have led to the router booting up in recovery mode. The only functionality provided here is the ability to clear the system log, filter by log level and downloading of the log file.

Status	Log	Application Installer	Settings	Reboot
Log File Display Level Debug Page 1 of 14 Clear Log File				
Date & Time	Machine	Level	Process	Message
Jan 1 00:01:15	nto_140wx	daemon.info	dnsmasq-dhcp[379]	DHCPINFORM(eth0) 192.168.1.129 00:02:19:0e:3a:19
Jan 1 00:01:11	nto_140wx	daemon.warn	dnsmasq-dhcp[379]	Ignoring domain corp.netcomm.com.au for DHCP host name NTCWKS0072
Jan 1 00:01:11	nto_140wx	daemon.info	dnsmasq-dhcp[379]	DHCPACK(eth0) 192.168.1.129 00:02:19:0e:3a:19 NTCWKS0072
Jan 1 00:01:11	nto_140wx	daemon.info	dnsmasq-dhcp[379]	DHCPREQUEST(eth0) 192.168.1.129 00:02:19:0e:3a:19
Jan 1 00:01:11	nto_140wx	daemon.info	dnsmasq-dhcp[379]	DHCPOFFER(eth0) 192.168.1.129 00:02:19:0e:3a:19
Jan 1 00:01:11	nto_140wx	daemon.warn	dnsmasq[379]	overflow: 5 log entries lost
Jan 1 00:00:05	nto_140wx	daemon.info	dnsmasq[379]	started, version 2.57 cachesize 150
Jan 1 00:00:48	nto_140wx	user.info	dispd[452]	[dispd] boot period time-out - sec=40 sec
Jan 1 00:00:18	nto_140wx	user.debug	kernel	[18.962219] eth0: no IPv6 routers present
Jan 1 00:00:08	nto_140wx	user.info	kernel	[8.169219] ADDRCONF(NETDEV_CHANGE): eth0: link becomes ready
Jan 1 00:00:08	nto_140wx	user.info	kernel	[8.164459] PHY: 0:01 - Link is Up - 10/Half
Jan 1 00:00:06	nto_140wx	user.info	dispd[452]	force to redraw all LEDs
Jan 1 00:00:06	nto_140wx	user.info	dispd[452]	[led-off] resetting dim timer (sec) - current timer=0
Jan 1 00:00:06	nto_140wx	user.info	dispd[452]	[led-off] set dim timer - timer=0 sec
Jan 1 00:00:06	nto_140wx	user.info	dispd[452]	reset all LEDs to solid off
Jan 1 00:00:06	nto_140wx	user.err	dispd[452]	set priority (prior=-20)
Jan 1 00:00:06	nto_140wx	user.info	dispd[452]	syslog LOG_INFO
Jan 1 00:00:06	nto_140wx	user.err	dispd[452]	syslog LOG_ERR
Jan 1 00:00:06	nto_140wx	user.err	dispd[452]	=====
Jan 1 00:00:06	nto_140wx	user.err	dispd[452]	loglevel check
Jan 1 00:00:06	nto_140wx	user.err	dispd[452]	=====
Jan 1 00:00:06	nto_140wx	user.info	kernel	[8.167114] PHY: 0:01 - Link is Down
Jan 1 00:00:06	nto_140wx	user.info	kernel	[8.158968] PHY: 0:01 - Link is Up - 0/Half

[Download Log File](#)

Figure 148 - Recovery mode - Log

Application Installer

The Application installer is designed to upload and install main firmware images, upload recovery firmware images, custom applications and HTTPS certificates. Use the **Browse** button to select a file to be uploaded to the router. When it has been selected, press the **Upload** button. The file is sent to the router and when the transfer is complete, the file appears in the Uploaded files list. From the Uploaded files list, you are able to either **Install** or **Delete** a file.

Status	Log	Application Installer	Settings	Reboot
--------	-----	-----------------------	----------	--------

[Recovery Console > Upload](#)

Upload:

File No file selected.

Uploaded Files:

Free Space: 86.0M

File Name	Date	Size	Action
ntc_140wx_vX.XX.XX.X.cdi	Jan 1 1970	32.9M	Install Delete
ntc_140wx_vX.XX.XX.X_r.cdi	Jan 1 1970	13.6M	Install Delete

Figure 149 - Recovery mode - Application Installer

Settings

The settings page provides the option of restoring the router to factory default settings. Click the **Restore** button to set the router back to the original factory settings.

Status	Log	Application Installer	Settings	Reboot
--------	-----	-----------------------	----------	--------

[Settings](#)

RESTORE FACTORY DEFAULTS:

Figure 150 - Recovery mode - Settings

Reboot

The reboot page allows you to reboot the router when you have finished using recovery mode. When rebooting the router from recovery mode, the router boots into the main firmware image unless there is some fault preventing it from doing so, in which case the recovery console will be loaded.

Click the **Reboot** button to reboot the router to the main firmware image.

Status	Log	Application Installer	Settings	Reboot
--------	-----	-----------------------	----------	--------

[Reboot](#)

To perform the reboot, click on the "Reboot" button below. You will be asked to confirm your decision.

Figure 151 - Recovery mode - Reboot

Appendix D: HTTPS - Uploading a self-signed certificate

If you have your own self-signed certificate or one purchased elsewhere and signed by a Certificate Authority, you can upload it to the NTC-140W Series router using the [Upload](#) page.



Note: Your key and certificate files must be named **server.key** and **server.crt** respectively otherwise they will not work.

To upload your certificate:

1. Click on the **System** item from the top menu bar. From the side menu bar, select **System Configuration** and then **Upload**. The file upload screen is displayed.

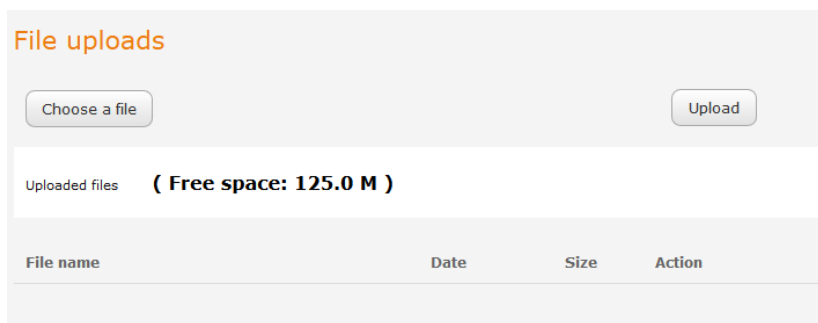

Figure 152 - Upload page

2. Click the **Choose a File** button and locate your server certificate file and click **Open**.

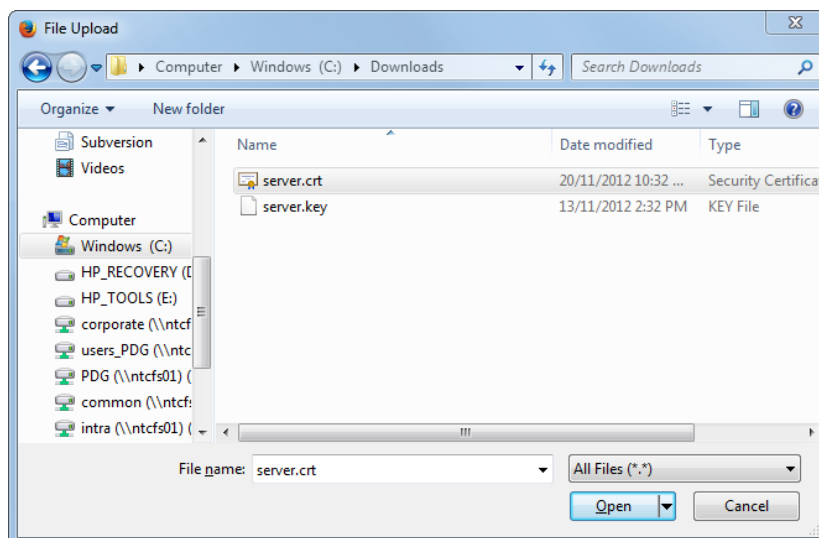

Figure 153 - Browse for server.crt

3. Click the **Upload** button to begin uploading it to the router. The file appears in the list of files stored on the router.

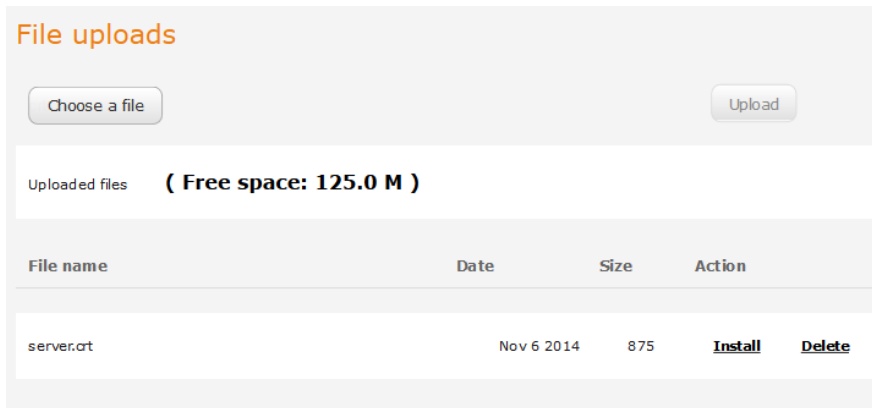

Figure 154 - Server certificate file uploaded

4. Repeat steps 2 and 3 for the server key file.
5. Click the **Install** link next to the server.crt file then click **OK** on the prompt that is displayed. The certificate file is installed. Repeat this for the key file. When each file is installed it is removed from the list of stored files.

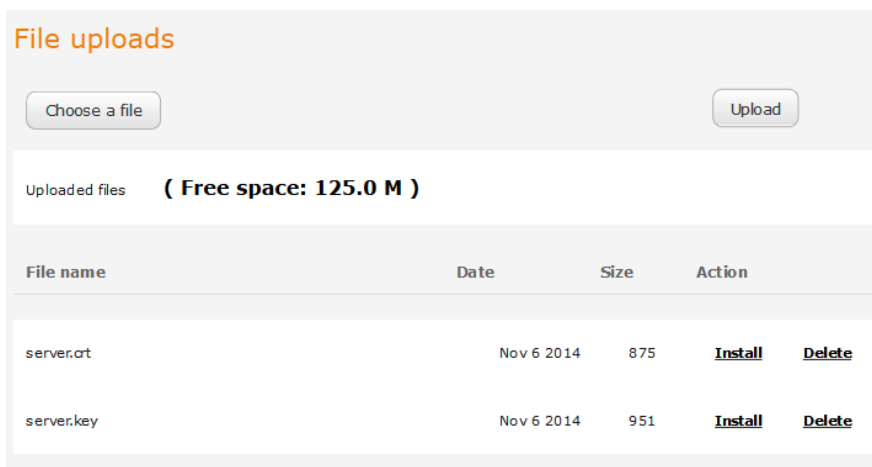

Figure 155 - Installing the server.crt file

Appendix E: RJ-45 connectors

The RJ-45 connectors provide an interface for a data connection and for device input power using the pin layout shown below.



Pin: 8 1

Figure 156 - The RJ-45 connector

PIN	COLOUR	SIGNAL (10/100)	SIGNAL (1000)
1	White/Orange stripe	Rx + DC +	+BI_DA
2	Orange Solid	Rx - DC +	-BI_DA
3	White/Green stripe	Tx + DC -	+BI_DB
4	Blue solid	unused	+BI_DC
5	White/Blue stripe	unused	-BI_DC
6	Green solid	Tx - DC -	-BI_DB
7	White/Brown stripe	unused	+BI_DD
8	Brown solid	unused	-BI_DD

Table 45 - RJ-45 connector pin outs

Appendix G: Input/Output

Overview

The NTC-140W series router is equipped with a 2 x 2 Molex connector providing a multipurpose input and output terminal as well as a dedicated ignition input. The I/O terminal may be independently configured for various functions, including:

- NAMUR (EN 60947-5-6 / IEC 60947-5-6) compatible sensor input
- Proximity sensor input for use with contact closure (open/closed) type of sensors (PIR sensors, door/window sensors for security applications) with the input tamper detection possible (four states detected: open, closed, short and break) by the use of external resistors
- Analogue 0V to 30V input
- Digital input (the I/O voltage measured by the Analogue input and the software making a decision about the input state) with the threshold levels configurable in software
- Open collector output.

Hardware Interface

The interface of the input/output terminals are based on the circuit diagram below

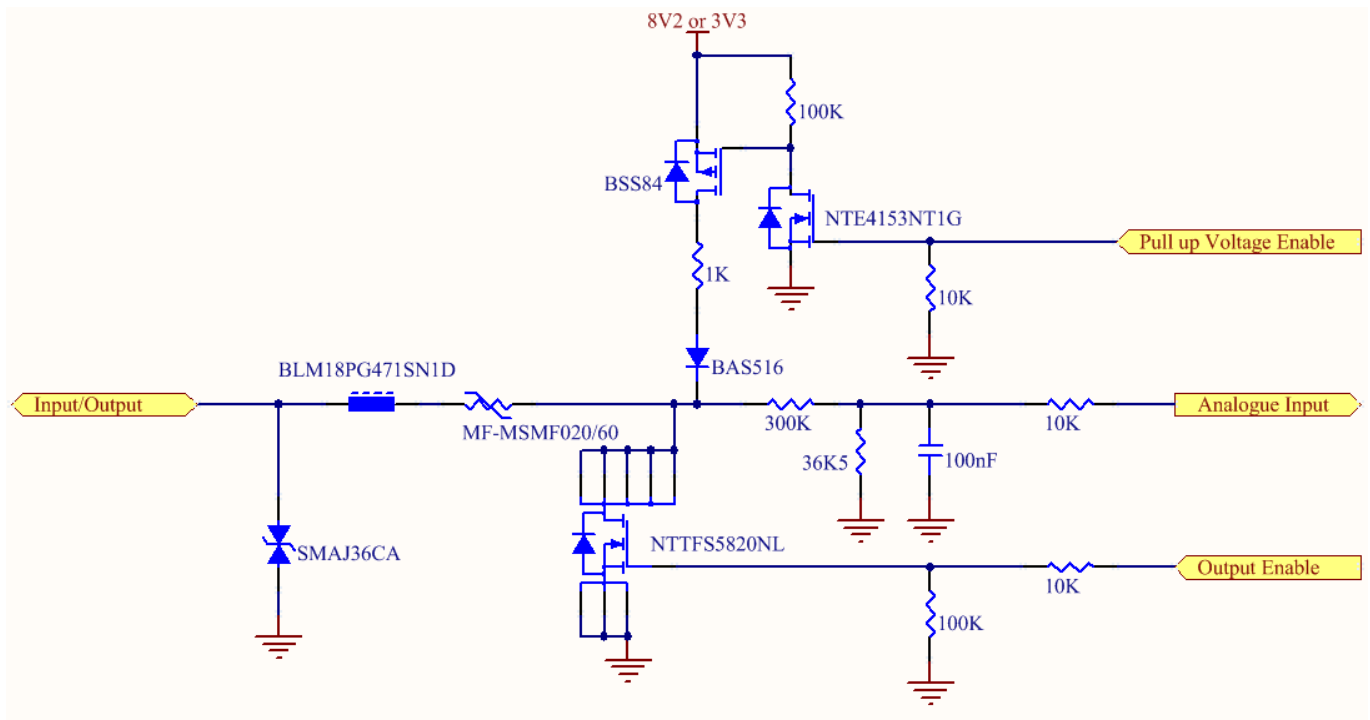

The **Input/Output** label is the physical connection to the outside world. There are protection devices and resistor dividers to condition the signal prior to it going into the processor. The three labels to the right are the interface to the processor. **Output Enable** activates the Transistor which provides an open collector (ground) output and can sink 200mA at 23°C. It is protected by a resettable fuse and transient protection diode. If used with the pull up resistor, which can be activated by the **Pull up Voltage Enable** pin, then you can have a High or Low output rather than open drain. The resistor can be pulled up to 3V3 for Cmos compatible output or 8.2V by software. The **Analogue Input** pin can read values from 0V to 30V. It is divided by a resistor network to read appropriate levels in the processor. Depending on the sensor type used, the pull up will be activated to 8V2 by default.

Wiring Examples

The following examples are shown as a guide as to what can be achieved by the I/O features. It is up to the system integrator to have enough knowledge about the interface to be able to achieve the required results.



Note: NetComm Wireless does not offer any further advice on the external wiring requirements or wiring to particular sensors, and will not be responsible for any damage to the unit or any other device used in conjunction with it. Using outputs to control high voltage equipment can be dangerous. The integrator must be a qualified electrician if dealing with mains voltages controlled by this unit.

Open Collector Output driving a relay

Any output can be configured to control a relay. This is an example where the transistor will supply the ground terminal of the solenoid. External voltage is supplied to the other side of the solenoid.

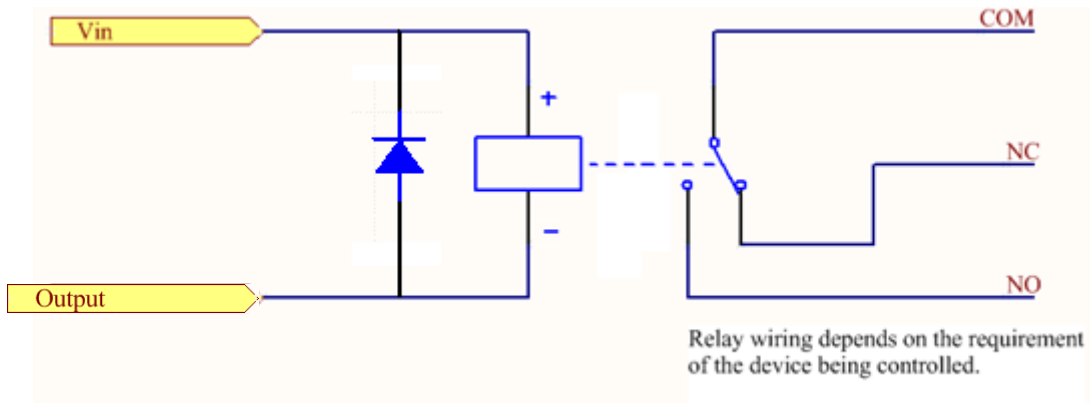

Logic level Output

An output can be used with the pull up resistor to provide a logic level output which would be suitable to control an external digital device.

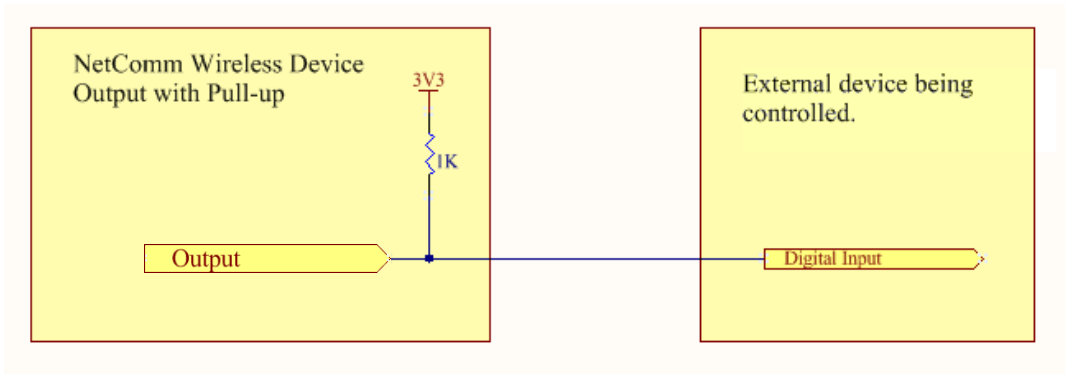

LED Output

An LED can be controlled by simply providing an open collector ground to an externally powered LED. Resistor value and Voltage will need to suit the LED type used. Alternatively an LED can be powered using 8V2 via 1K resistor. The suitability of the LED will need to be investigated.

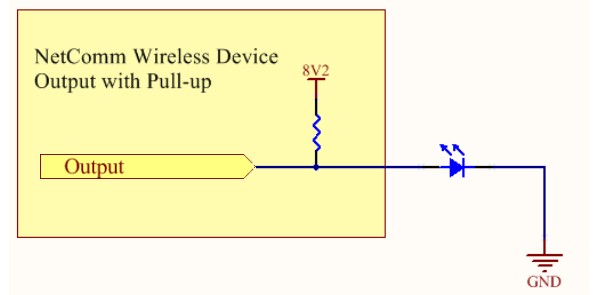
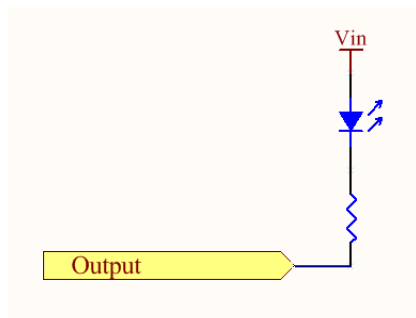

Digital inputs

There are several ways to connect a digital input. A digital input can be anything from a simple switch to a digital waveform or pulses. The unit will read the voltage in as an analogue input and the software will decode it in a certain way depending on your configuration.

Below is a contact closure type input, which is detecting an Earth. Pull up is activated for this to work.

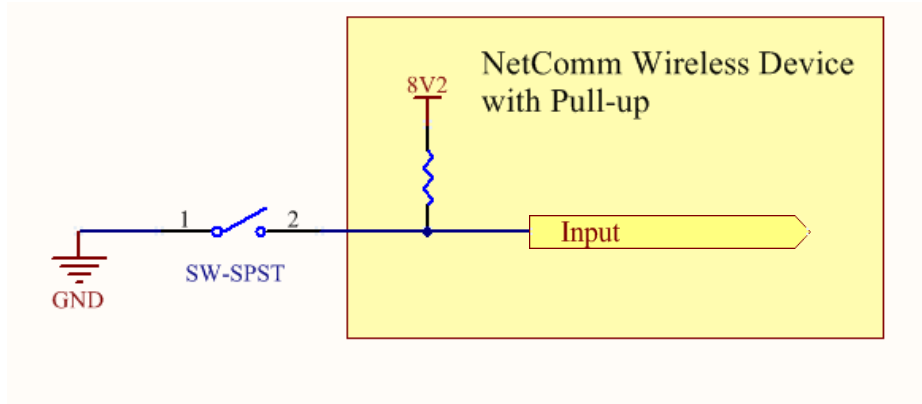

The following input detects an input going high. The turn on/off threshold can be set in the software.

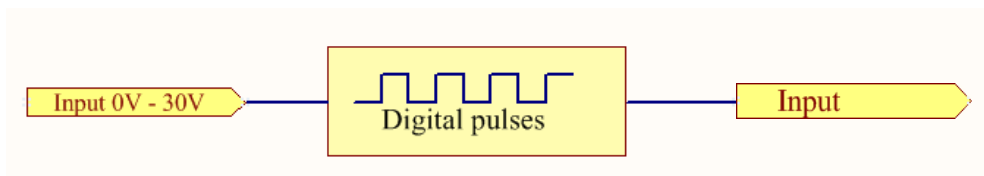
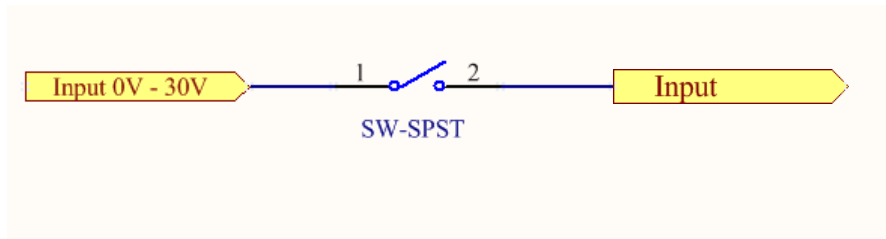

NAMUR Sensor

A NAMUR sensor is a range of sensors which conform to the EN 60947-5-6 / IEC 60947-5-6 standards. They basically have two states which are reflected by the amount of current running through a sense resistor.

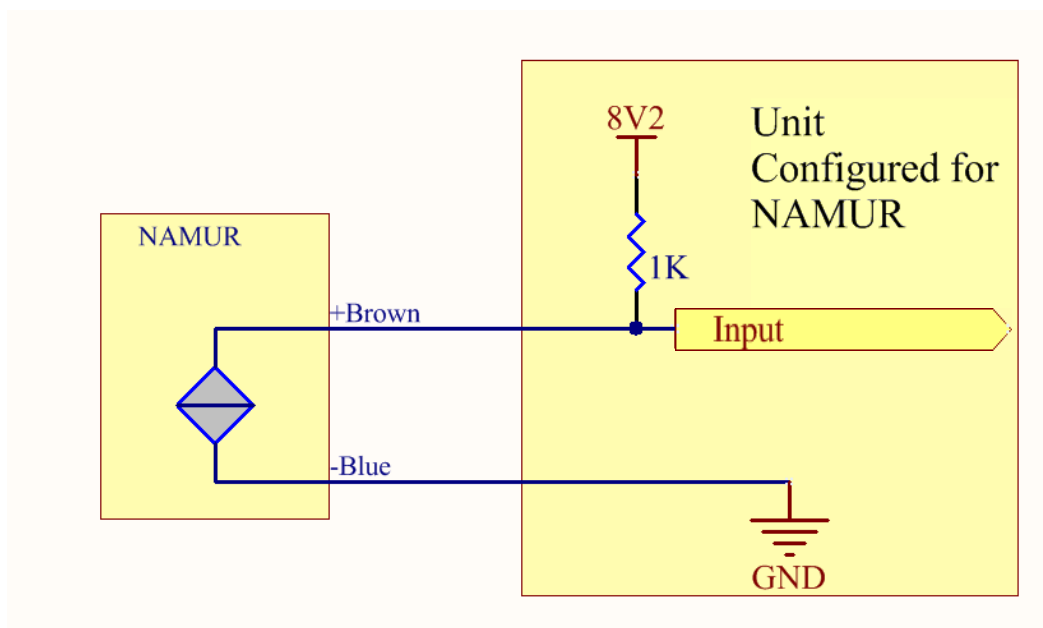

Analogue Sensor with Voltage output

There are various analogue sensors that connect directly to the unit which can provide a voltage output. These would require an external power source which may or may not be the same as the unit itself. The voltage range they provide can be between 0V and 30V. Some common sensor output ranges include 0V to 10V. The pull up resistor is not activated in this case.

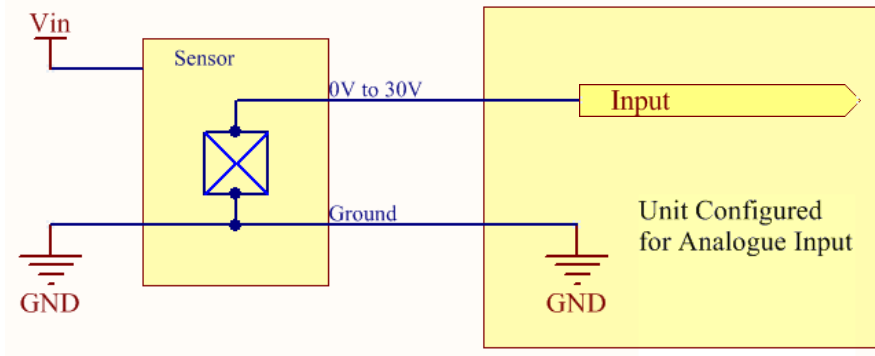

Analogue Sensor with 4 to 20mA output

Another common type of sensor type is the 4-20mA current loop sensor. It provides a known current through a fixed resistor, usually 250 ohms thus producing a voltage of 0v to 5V at the input. The sensor would require an external power source which may or may not be the same as the unit itself. It will also require an external resistor. The internal pull up resistor is not activated.

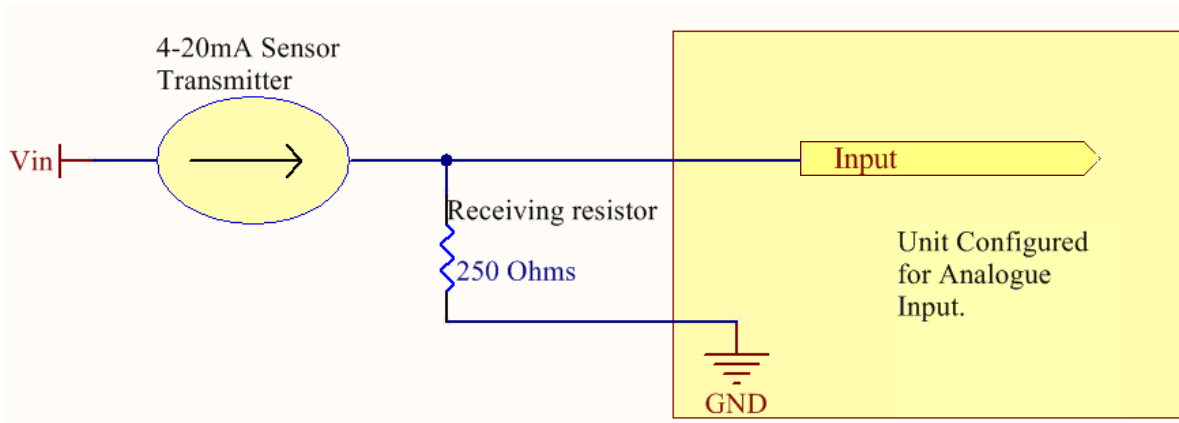

Analogue Sensor with Thermistor

Some sensors work by changing resistance due to a change, such as temperature, light etc. These may be wired up to an external or internal power source and the resistance can be read into the analogue signal. This will require some software calibration like scaling or offset to map the voltage received to the sensor resistor value. An example below shows the internal pull-up voltage and 1K resistor activated. The voltage received depends on the combination of resistors and the value of the resistance of the sensor itself.

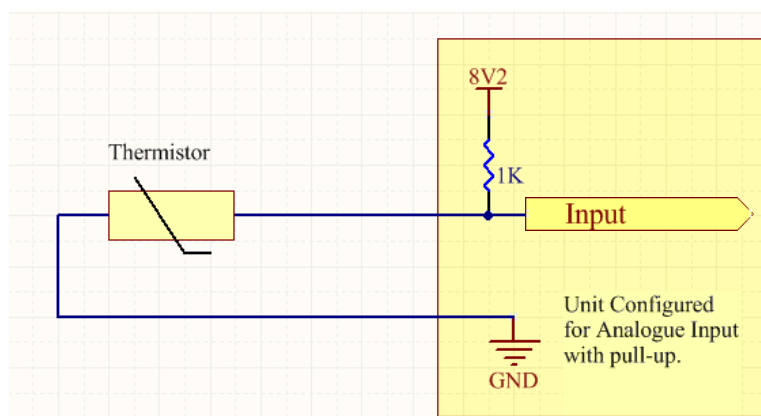

System Example –Solar powered Router with battery backup

The previous examples of wiring can be used to come up with a system. The following test case is an example of how the I/O's can be used to enhance a simple router setup.

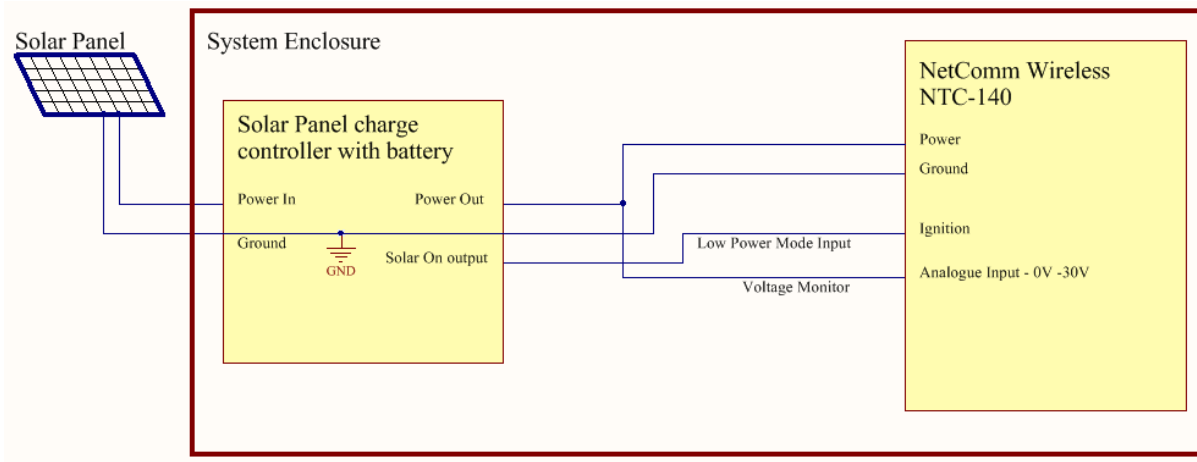

Appendix H: Obtaining a list of RDB variables

The RDB is a database of variables that contain settings on the router. You can retrieve (get) and set the values of these variables through the command-line or via SMS Diagnostics. To access a full list of the RDB variables, follow these steps:

1. Log in to the web user interface as described in the [Advanced configuration](#) section of this guide.
2. Click the **System** menu at the top of the screen, then select the **Administration** menu on the left. Finally, select the **Administration settings** menu item.
3. Click the **Enable Telnet** toggle key so that it is in the **ON** position.



4. Under the **Telnet/SSH account** section, enter a telnet password and then re-enter it in the **Confirm password** field.
5. Click the **Save** button at the bottom of the screen.
6. Open a terminal client such as PuTTY and telnet to the router using its IP address.

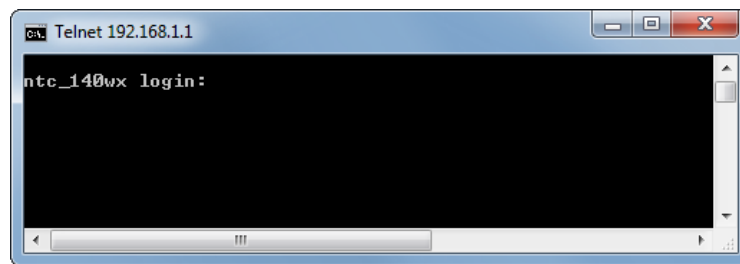

7. At the login prompt, type **root** and press Enter. At the password prompt, enter the password that you configured in step 4.
8. At the root prompt, enter the command **rdb dump | more**. This will display a list of every rdb variable on the router one page at a time.

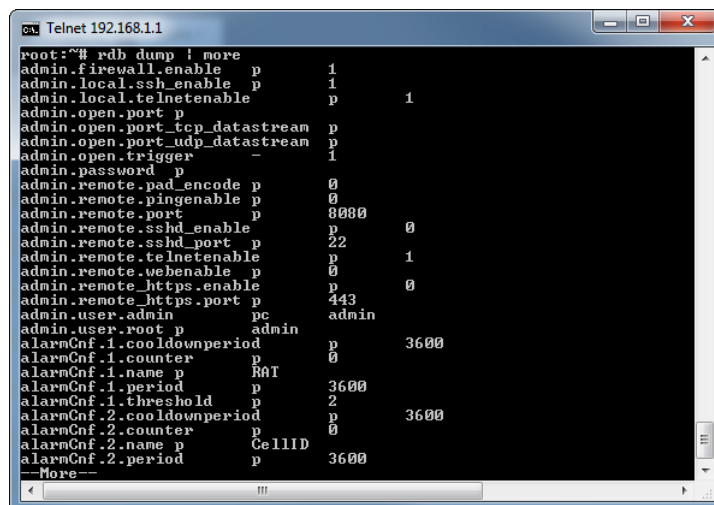

Note: Omitting the **| more** parameter will dump a complete list without pagination. For easier access, some terminal clients such as PuTTY have the ability to log all telnet output to a text file.

Appendix I: Using USB devices and MicroSD™ cards

The NTC-140W Series router features a Micro USB 2.0 OTG port capable of supplying 0.5A to connected devices and a microSD™ card slot allowing additional storage. The Micro USB port supports both USB storage devices as well as certain USB accessories, including USB-to-Ethernet adapters and USB-to-Serial cables.

Accessing USB/SD card storage devices

When a USB storage device or microSD™ card is inserted, the router automatically mounts the storage. To access storage devices:

Windows

1. Open Windows Explorer.
2. In the address bar, type in the network address of the router ([\\my.router](#) or [\\192.168.1.1](#) by default), and press Enter. The storage devices are labelled Disk A, Disk B or Disk C.

Mac OS

1. In Mac OS, open a Finder window.
2. Select Go -> Connect to Server.
3. Enter the server address `smb://my.router` or `smb://192.168.1.1`
4. Select the volumes you want to mount. Storage devices are labelled Disk A, Disk B or Disk C.

Linux / Smartphones

You can use any Samba client on Linux and Smartphones to access the connected storage devices by navigating to “my.router” or “192.168.1.1” in your chosen Samba client.

Host and Device mode

The USB port automatically detects whether to run in host or device mode. When in host mode, the router automatically mounts USB storage devices. When in device mode, the router supports Ethernet over USB. It is also possible to configure the USB Ethernet port as a WAN port.

Technical Data

The following tables list the hardware specifications of the NTC-140W Series routers.

COMPONENT	NTC-140W-01	NTC-140W-02
Memory	256MByte Flash memory storage (~120MB available on board space for user storage)	
Operating System	Embedded Linux & Software Development Kit (SDK)	
Cellular bands	<p><u>LTE:</u></p> <ul style="list-style-type: none"> • Band 2 (1900 MHz) • Band 4 (AWS) (1700 / 2100 MHz) • Band 5 (850 MHz) • Band 13 (700 MHz) • Band 17 (700 MHz) • Band 25 (1900 MHz G Block) <p><u>CDMA (EVDO Release 0 and EVDO Release A):</u></p> <ul style="list-style-type: none"> • BC0 (Cellular 800 MHz) • BC1 (PCS 1900 MHz) • BC10 (Secondary 800 MHz) <p><u>UMTS/HSDPA/HSUPA/HSPA+/DC-HSPA+:</u></p> <ul style="list-style-type: none"> • Band 1 (2100 MHz) • Band 2 (1900 MHz) • Band 4 (AWS 1700/2100 MHz) • Band 5 (850 MHz) • Band 8 (900 MHz) <p><u>GSM/GPRS/EDGE:</u></p> <ul style="list-style-type: none"> • GSM 850 (850 MHz) • EGSM 900 (900 MHz) • DCS 1800 (1800 MHz) • PCS 1900 (1900 MHz) 	<p><u>LTE:</u></p> <ul style="list-style-type: none"> • Band 1 (2100 MHz) • Band 3 (1800 MHz) • Band 7 (2600 MHz) • Band 8 (900 MHz) • Band 20 (800 MHz) <p><u>UMTS/HSDPA/HSUPA/HSPA+/DC-HSPA+:</u></p> <ul style="list-style-type: none"> • Band 1 (2100 MHz) • Band 2 (1900 MHz) • Band 5 (850 MHz) • Band 8 (900 MHz) <p><u>GSM/GPRS/EDGE:</u></p> <ul style="list-style-type: none"> • GSM 850 (850 MHz) • EGSM 900 (900 MHz) • DCS 1800 (1800 MHz) • PCS 1900 (1900 MHz) <p><u>GNSS:</u></p> <ul style="list-style-type: none"> • GPS: 1575.42 MHz • GLONASS: 1602 MHz
Maximum Data Throughput / LTE Radio interface	<p><u>LTE data rates:</u> Category 3</p> <ul style="list-style-type: none"> • Downlink: 100 Mbps (20 MHz bandwidth), 50 Mbps (10 MHz bandwidth) • Uplink: 50 Mbps (20 MHz bandwidth), 25 Mbps (10 MHz bandwidth) <p><u>CDMA EVDO Release 0 and EVDO Release A</u> CDMA IS-856 (1xEV-DO Release A)</p> <ul style="list-style-type: none"> • Up to 3.1 Mbps forward channel • Up to 1.8 Mbps reverse channel <p>CDMA IS-2000</p> <ul style="list-style-type: none"> • Up to 153 kbps, simultaneous forward and reverse channel <p>Circuit-switched data bearers up to 14.4 kbps</p> <p><u>UMTS (WCDMA)/HSDPA/HSUPA/HSPA+/DC-HSPA+ HSPA+ rates</u></p> <ul style="list-style-type: none"> • Downlink: Up to 42 Mbps (category 24) • Uplink: Up to 5.76 Mbps (category 6) <p><u>GSM/GPRS/EDGE</u></p> <ul style="list-style-type: none"> • EDGE throughput up to 236 kbps 	<p><u>LTE data rates:</u> Category 3</p> <ul style="list-style-type: none"> • Downlink: 100 Mbps (20 MHz bandwidth) • Uplink: 50 Mbps (20 MHz bandwidth) <p>50 Mbps (10 MHz bandwidth)</p> <p>25 Mbps (10 MHz bandwidth)</p> <p><u>UMTS (WCDMA)/HSDPA/HSUPA/HSPA+/DC-HSPA+ HSPA+ rates</u></p> <ul style="list-style-type: none"> • Downlink: Up to 42 Mbps (category 24) • Uplink: Up to 5.76 Mbps (category 6) <p><u>GSM/GPRS/EDGE</u></p> <ul style="list-style-type: none"> • EDGE throughput up to 236 kbps
Connectivity	2 x 10/100/1000 Base-T Ethernet RJ45 ports with Auto MDIX Micro USB 2.0 OTG interface with 0.5A supply capability 1 x multipurpose I/O pin	
SIM Card Reader	1 x Lockable SIM Card Tray Reader, Push to Release	
Antenna connectors	2x SMA connectors for Cellular (1x Main and 1x RX Diversity) 1x SMA connector for GPS 2x Reverse-SMA WLAN (MIMO)	
LED Indicators	Tri-colour (Red/Amber/Green) LEDs. Power, WLAN, Mobile Broadband, Service Type and Signal Strength indicators	
GPS	<p>Embedded GPS receiver (1575.42Mhz)</p> <p>Active antenna voltage: 3.05V</p> <p>Maximum current: 50mA</p> <p>Tracking sensitivity under open sky: -159dBm</p> <p>Acquisition sensitivity under open sky: -149dBm</p> <p>Cold start sensitivity: -145dBm</p> <p>Time to first fix (TTFF): Cold 25s, Warm 10s, Hot 3s</p> <p>Short circuit protection</p> <p>Supports NMEA-0183 (v2.3)</p>	

	Redirect NMEA stream to serial for forward over IP Odometer reading available via Web-UI, CLI and SDK	
Operating Temperature	Operating Temperature Range (Class A): -30°C to +70°C Operating Temperature Range (Class B)*: -40°C to +85°C *with performance deviation	
Power input	Power input and I/O via 4 way Molex mini-fit connector DC Power (8 - 40V DC) 1x dedicated ignition input on 4 way connector Minimum power input rating of 6W via 4 way mini-fit connector. Recommended power input 12V 1.5A. Vehicle compatible protection on DC Input Jack. (Designed to ISO7637 standard)	
Dimensions & Weight	143mm (L) x 107mm (W) x 34mm (D) / ~235g	
Regulatory Compliance	FCC, IC, Designed to ISO7637 standard	CE, GCF, RCM, Designed to ISO7637 standard.

Table 46 - Technical Specifications of the NTC-140W-01 and NTC-140W-02 routers

Safety and product care

RF Exposure

Your device contains a transmitter and a receiver. When it is on, it receives and transmits RF energy. When you communicate with your device, the system handling your connection controls the power level at which your device transmits.

This device meets the government's requirements for exposure to radio waves.

This device is designed and manufactured not to exceed the emission limits for exposure to radio frequency (RF) energy set by the Federal Communications Commission of the U.S. Government.

This equipment complies with radio frequency (RF) exposure limits adopted by the Federal Communications Commission for an uncontrolled environment. This equipment should be installed and operated with minimum distance 20 cm between the radiator & your body.

Déclaration d'exposition aux radiations:

Cet équipement est conforme aux limites d'exposition aux rayonnements IC établies pour un environnement non contrôlé. Cet équipement doit être installé et utilisé avec un minimum de 20 cm de distance entre la source de rayonnement et votre corps.

Tout gain d'antenne externe doit répondre l'exposition aux radiofréquences et les limites de puissance de sortie maximum rayonnée de la section de la règle applicable. Le gain maximal de l'antenne de cet appareil est:

NTC-140W-01

WWAN: 3.03 dBi (1710-1855MHz)

WLAN: 2dBi

Type d'antenne WLAN: Antenne dipolaire

NTC-140W-02

WWAN: 3.74 dBi (2500-2690MHz)

WLAN: 2dBi

Type d'antenne WLAN: Antenne dipolaire

Conformément à la réglementation d'Industrie Canada, le présent émetteur radio peut fonctionner avec une antenne d'un type et d'un gain maximal (ou inférieur) approuvé pour l'émetteur par Industrie Canada. Dans le but de réduire les risques de brouillage radioélectrique à l'intention des autres utilisateurs, il faut choisir le type d'antenne et son gain de sorte que la puissance isotrope rayonnée équivalente (p.i.r.e.) ne dépasse pas l'intensité nécessaire à l'établissement d'une communication satisfaisante.

Le présent émetteur radio FCC ID: XIA-NTC140W, IC: 8847A-NTC140W a été approuvé par Industrie Canada pour fonctionner avec les types d'antenne énumérés ci-dessus et ayant un gain admissible maximal et l'impédance requise pour chaque type d'antenne. Les types d'antenne non inclus dans cette liste, ou dont le gain est supérieur au gain maximal indiqué, sont strictement interdits pour l'exploitation de l'émetteur.

External antenna

Any optional external antenna used for this transmitter must be installed to provide a separation distance of at least 20 cm from all persons and must not be co-located or operated in conjunction with any other antenna or transmitter. Please consult the health and safety guide of the chosen antenna for specific body separation guidelines as a greater distance of separation may be required for high-gain antennas.

Any external antenna gain must meet RF exposure and maximum radiated output power limits of the applicable rule section. The maximum antenna gain for this device is:

NTC-140W-01

WWAN: 3.03 dBi (1710-1855MHz)

WLAN: 2dBi

WLAN antenna type: Dipole antenna

NTC-140W-02

WWAN: 3.74 dBi (2500-2690MHz)

WLAN: 2dBi

WLAN antenna type: Dipole antenna

Under Industry Canada regulations, this radio transmitter may only operate using an antenna of a type and maximum (or lesser) gain approved for the transmitter by Industry Canada. To reduce potential radio interference to other users, the antenna type and its gain should be so chosen that the equivalent isotropically radiated power (e.i.r.p.) is not more than that necessary for successful communication

This radio transmitter FCC ID: XIA-NTC140W, IC: 8847A-NTC140W has been approved by Industry Canada to operate with the antenna types listed below with the maximum permissible gain and required antenna impedance for each antenna type indicated. Antenna types not included in this list, having a gain greater than the maximum gain indicated for that type, are strictly prohibited for use with this device.

CE Approval

This device has been tested to and conforms to the regulatory requirements of the European Union and attained CE Marking. The CE Mark is a conformity marking consisting of the letters "CE." The CE Mark applies to the products regulated by the central European health, safety and environmental protection legislation. The CE Mark is obligatory for products it applies to: the manufacturer affixes the marking in order to be allowed to sell their product in the European market.

The wireless device is approved to be used in the member states of the EU. NetComm Wireless declares that the wireless device is in compliance with the essential requirements and other relevant provisions of the Radio and Telecommunications Terminal Equipment Directive 1999/5/EC (R&TTE Directive). Compliance with this directive implies conformity to the following European Norms – N 60950 – Product Safety, EN 301 489 EMC, EN301511 GSM RF, EN301908 UMTS RF, EN 62311 SAR Technical requirement for radio equipment. A notified body has determined that this device has properly demonstrated that the requirements of the directive have been met and has issued a favourable certificate of expert opinion. As such the device will bear the notified body number 0682 after the CE mark.

The CE Marking is not a quality mark. Foremost, it refers to the safety rather than to the quality of the product. Secondly, CE Marking is mandatory for the product it applies to whereas most quality markings are voluntary.

Marking: The product shall bear the CE mark, the notified body number(s) as depicted to the right. **CE 0682**

NOTE: To comply with the RF exposure requirements, this equipment must be operated with a minimum of 20 cm separation from the user.

This is a regulatory requirement and applies to all 3G capable devices meeting standard regulatory compliance such as the compliance standards listed above.

FCC Statement





FCC compliance

Federal Communications Commission Notice (United States): Before a wireless device model is available for sale to the public, it must be tested and certified to the FCC that it does not exceed the limit established by the government-adopted requirement for safe exposure.

FCC regulations

This device complies with part 15 of the FCC Rules. Operation is subject to the following two conditions: (1) This device may not cause harmful interference, and (2) this device must accept any interference received, including interference that may cause undesired operation.

This device has been tested and found to comply with the limits for a Class B digital device, pursuant to Part 15 of the FCC Rules. These limits are designed to provide reasonable protection against harmful interference in a residential installation. This equipment generates, uses and can radiate radio frequency energy and, if not installed and used in accordance with the instructions, may cause harmful interference to radio communications. However, there is no guarantee that interference will not occur in a particular installation. If this equipment does cause harmful interference to radio or television reception, which can be determined by turning the equipment off and on, the user is encouraged to try to correct the interference by one or more of the following measures:

-  Reorient or relocate the receiving antenna.
-  Increase the separation between the equipment and receiver.
-  Connect the equipment into an outlet on a circuit different from that to which the receiver is connected.
-  Consult the dealer or an experienced radio/TV technician for help.

Changes or modifications not expressly approved by the party responsible for compliance could void the user's authority to operate the equipment.

IC regulations

CAN ICES-3(B)/NMB-3(B)

This device complies with Industry Canada licence-exempt RSS standard(s). Operation is subject to the following two conditions:

- (1) this device may not cause interference, and
- (2) this device must accept any interference, including interference that may cause undesired operation of the device.

Le présent appareil est conforme aux CNR d'Industrie Canada applicables aux appareils radio exempts de licence. L'exploitation est autorisée aux deux conditions suivantes:

- (1) l'appareil ne doit pas produire de brouillage, et
- (2) l'utilisateur de l'appareil doit accepter tout brouillage radioélectrique subi, même si le brouillage est susceptible d'en compromettre le fonctionnement."

This Class B digital apparatus complies with Canadian CAN ICES-3 (B)/NMB-3(B).

Cet appareil numérique de la classe B est conforme à la norme NMB-003 du Canada.

IMPORTANT NOTE:

IC radiation exposure statement:

This equipment complies with IC RSS-102 radiation exposure limits set forth for an uncontrolled environment. This equipment should be installed and operated with minimum distance 20cm between the radiator and users body.

Electrical safety

Accessories

Only use approved accessories.

Do not connect with incompatible products or accessories.

Connection to a car

Seek professional advice when connecting a device interface to the vehicle electrical system.

Distraction

Operating machinery

Full attention must be given to operating the machinery in order to reduce the risk of an accident.

Product handling

You alone are responsible for how you use your device and any consequences of its use.

You must always switch off your device wherever the use of a mobile phone is prohibited. Do not use the device without the clip-on covers attached, and do not remove or change the covers while using the device. Use of your device is subject to safety measures designed to protect users and their environment.

Always treat your device and its accessories with care and keep it in a clean and dust-free place.

Do not expose your device or its accessories to open flames or lit tobacco products.

Do not expose your device or its accessories to liquid, moisture or high humidity.

Do not drop, throw or try to bend your device or its accessories.

Do not use harsh chemicals, cleaning solvents, or aerosols to clean the device or its accessories.

Do not paint your device or its accessories.

Do not attempt to disassemble your device or its accessories, only authorised personnel must do so.

Do not use or install this product in extremely hot or cold areas. Ensure that the device is installed in an area where the temperature is within the supported operating temperature range (-20°C to 70°C)

Do not use your device in an enclosed environment or where heat dissipation is poor. Prolonged use in such space may cause excessive heat and raise ambient temperature, which will lead to automatic shutdown of your device or the disconnection of the mobile network connection for your safety. To use your device normally again after such shutdown, cool it in a well-ventilated place before turning it on.

Please check local regulations for disposal of electronic products.

Do not operate the device where ventilation is restricted

Installation and configuration should be performed by trained personnel only.

Do not use or install this product near water to avoid fire or shock hazard. Avoid exposing the equipment to rain or damp areas.

Arrange power and Ethernet cables in a manner such that they are not likely to be stepped on or have items placed on them.

Ensure that the voltage and rated current of the power source match the requirements of the device. Do not connect the device to an inappropriate power source.

Small children

Do not leave your device and its accessories within the reach of small children or allow them to play with it.

They could hurt themselves or others, or could accidentally damage the device.

Your device contains small parts with sharp edges that may cause an injury or which could become detached and create a choking hazard.

Emergency & other situations requiring continuous connectivity

This device, like any wireless device, operates using radio signals, which cannot guarantee connection in all conditions. Therefore, you must never rely solely on any wireless device for emergency communications or otherwise use the device in situations where the interruption of data connectivity could lead to death, personal injury, property damage, data loss, or other loss.

Device heating

Your device may become warm during normal use.

Faulty and damaged products

Do not attempt to disassemble the device or its accessories.

Only qualified personnel must service or repair the device or its accessories.

If your device or its accessories have been submerged in water punctured or subjected to a severe fall, do not use until they have been checked at an authorised service centre.

Interference

Care must be taken when using the device in close proximity to personal medical devices, such as pacemakers and hearing aids.

Pacemakers

Pacemaker manufacturers recommend that a minimum separation of 15cm be maintained between a device and a pacemaker to avoid potential interference with the pacemaker.

Hearing aids

People with hearing aids or other cochlear implants may experience interfering noises when using wireless devices or when one is nearby.

The level of interference will depend on the type of hearing device and the distance from the interference source, increasing the separation between them may reduce the interference. You may also consult your hearing aid manufacturer to discuss alternatives.

Medical devices

Please consult your doctor and the device manufacturer to determine if operation of your device may interfere with the operation of your medical device.

Hospitals

Switch off your wireless device when requested to do so in hospitals, clinics or health care facilities. These requests are designed to prevent possible interference with sensitive medical equipment.

Interference in cars

Please note that because of possible interference to electronic equipment, some vehicle manufacturers forbid the use of devices in their vehicles unless an external antenna is included in the installation.

Explosive environments

Petrol stations and explosive atmospheres

In locations with potentially explosive atmospheres, obey all posted signs to turn off wireless devices such as your device or other radio equipment.

Areas with potentially explosive atmospheres include fuelling areas, below decks on boats, fuel or chemical transfer or storage facilities, areas where the air contains chemicals or particles, such as grain, dust, or metal powders.

Blasting caps and areas

Turn off your device or wireless device when in a blasting area or in areas posted turn off “two-way radios” or “electronic devices” to avoid interfering with blasting operations.

Product Warranty

For warranty information please visit

<http://www.netcommwireless.com/product/m2m/ntc-140w>